



(IRM-60)



(IRM-60-xxST)



Features

- 3.43"x2.05" compact size
- PCB, chassis or screw terminal mounting version
- Universal input 85~305VAC
- No load power consumption < 0.15W
- EMI Class B without additional components
- Wide operating temp. range -30~70°C
- Protections: Short circuit / Overload / Over voltage
- Cooling by free air convection
- Isolation Class II
- Over voltage category III
- Pass LPS (Except for 5V)
- 3 years warranty

Applications

- Industrial electrical equipment
- Mechanical equipment
- Factory automation equipment
- Handheld electronic device

GTIN CODE

MW Search: <https://www.meanwell.com/serviceGTIN.aspx>

Description

IRM-60 is a 60W miniature (87*52*29.5mm) AC-DC module-type power supply, ready to be soldered onto the PCB boards of various kinds of electronic instruments or industrial automation equipments. This product allows the universal input voltage range of 85~305VAC. The 94V-0 flame retardant plastic case and potted with silicone enhance the heat dissipation. PCB mounting style model (Blank) meet the anti-vibration demand up to 2G and screw terminal style model (ST) meet the anti-vibration demand up to 5G; moreover, it provides the fundamental resistance to dust and moisture.

With the high efficiency up to 91% and the extremely low no-load power consumption below 0.15W, IRM-60 series fulfills the worldwide regulation for the low power consumption requirement for electronics. The entire series is a Class II design (no FG pin), incorporating the built-in EMI filtering components, enabling the compliance with BS EN/EN55032 Class B; the supreme EMC features keep the end electronic units from electromagnetic interference. In addition to the PCB mounting style model, IRM-60 series also offers the screw terminal style model (ST).

Model Encoding

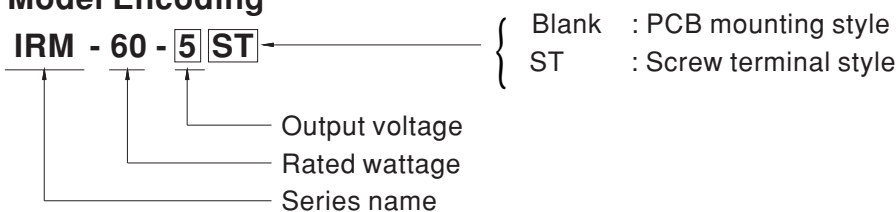

SPECIFICATION

MODEL	IRM-60-5 □	IRM-60-12 □	IRM-60-15 □	IRM-60-24 □	IRM-60-48 □		
OUTPUT	DC VOLTAGE	5V	12V	15V	24V	48V	
	RATED CURRENT	10A	5A	4A	2.5A	1.25A	
	CURRENT RANGE	0 ~ 10A	0 ~ 5A	0 ~ 4A	0 ~ 2.5A	0 ~ 1.25A	
	RATED POWER	50W	60W	60W	60W	60W	
	RIPPLE & NOISE (max.) Note.2	80mVp-p	120mVp-p	120mVp-p	150mVp-p	240mVp-p	
	VOLTAGE TOLERANCE Note.3	±2.5%	±2.5%	±2.5%	±2.5%	±2.5%	
	LINE REGULATION	±0.5%	±0.5%	±0.5%	±0.5%	±0.5%	
	LOAD REGULATION	±1.0%	±1.0%	±0.5%	±0.5%	±0.5%	
	SETUP, RISE TIME	1000ms, 30ms/230VAC 2000ms, 30ms/115VAC at full load					
	HOLD UP TIME (Typ.)	50ms/230VAC 12ms/115VAC at full load					
INPUT	VOLTAGE RANGE	85 ~ 305VAC					
	FREQUENCY RANGE	47 ~ 440Hz					
	EFFICIENCY (Typ.)	84%	87.5%	89%	90%	91%	
	AC CURRENT (Typ.)	1.8A/115VAC 1.0A/230VAC 0.9A/277VAC					
	INRUSH CURRENT (Typ.)	COLD START 30A/115VAC 60A/230VAC					
	LEAKAGE CURRENT	< 0.25mA/277VAC					
PROTECTION	OVERLOAD	115%~160% rated output power Protection type : Hiccup mode, recovers automatically after fault condition is removed					
	OVER VOLTAGE	5.25 ~ 6.75V	12.6 ~ 16.2V	15.75 ~ 20.25V	25.2 ~ 32.4V	50.4 ~ 64.8V	
ENVIRONMENT	WORKING TEMP.	-30 ~ +70°C (Refer to "Derating Curve")					
	WORKING HUMIDITY	20 ~ 90% RH non-condensing					
	STORAGE TEMP., HUMIDITY	-40 ~ +85°C, 10 ~ 95% RH					
	TEMP. COEFFICIENT	±0.03%/°C (0 ~ 50°C)					
	VIBRATION	Blank:10 ~ 500Hz, 2G 10min./1cycle, period for 60min. each along X, Y, Z axes					
		ST:10 ~ 500Hz, 5G 10min./1cycle, period for 60min. each along X, Y, Z axes					
	SOLDERING TEMPERATURE	Wave soldering: 265°C, 5s (max.); Manual soldering: 390°C, 3s (max.)					
	OVER VOLTAGE CATEGORY	III; According to EN62368-1; altitude up to 2000 meters					
	OPERATING ALTITUDE Note.4	2000 meters					
SAFETY & EMC (Note.5)	SAFETY STANDARDS	IEC62368-1, UL62368-1, TUV BS EN/EN62368-1, BS EN/EN60335-1, EAC TP TC 004, BSMI CNS14336-1 approved					
	WITHSTAND VOLTAGE	I/P-O/P:4KVAC					
	ISOLATION RESISTANCE	I/P-O/P:100M Ohms / 500VDC / 25°C / 70% RH					
	EMC EMISSION	Parameter	Standard			Test Level / Note	
		Conducted	BS EN/EN55032(CISPR32), CNS13438			Class B	
		Radiated	BS EN/EN55032(CISPR32), CNS13438			Class B	
		Harmonic Current (Note 5)	BS EN/EN61000-3-2			Class A	
		Voltage Flicker	BS EN/EN61000-3-3			-----	
	EMC IMMUNITY	BS EN/EN55035, BS EN/EN61000-6-2					
		Parameter	Standard			Test Level /Note	
ESD		BS EN/EN61000-4-2			Level 3, 8KV air; Level 2, 4KV contact, criteria A		
Radiated Susceptibility		BS EN/EN61000-4-3			Level 3, criteria A		
EFT/Burest		BS EN/EN61000-4-4			Level 3, criteria A		
Surge		BS EN/EN61000-4-5			Level 4, 2KV/L-N, criteria A		
Conducted		BS EN/EN61000-4-6			Level 3, criteria A		
Magnetic Field		BS EN/EN61000-4-8			Level 4, criteria A		
Voltage Dips and interruptions	BS EN/EN61000-4-11			>95% dip 0. 5 periods, 30% dip 25 periods, >95% interruptions 250 periods			
OTHERS	MTBF	6433.3K hrs min. Telcordia SR-332 (Bellcore) ; 1226.3K hrs min. MIL-HDBK-217F (25°C)					
	DIMENSION	PCB mounting style : 87*52*29.5mm (L*W*H) Screw terminal style : 109*52*33.5mm (L*W*H)					
	PACKING	PCB mounting style : 0.195Kg;60pcs/12.7Kg/0.94CUFT Screw terminal style : 0.228Kg;50pcs/12.4Kg/0.56CUFT					
NOTE	<p>1. All parameters NOT specially mentioned are measured at 230VAC input, rated load and 25°C of ambient temperature.</p> <p>2. Ripple & noise are measured at 20MHz of bandwidth by using a 12" twisted pair-wire terminated with a 0.1 μF & 47 μF parallel capacitor.</p> <p>3. Tolerance : includes set up tolerance, line regulation and load regulation.</p> <p>4. The ambient temperature derating of 3.5°C/1000m with fanless models and of 5°C/1000m with fan models for operating altitude higher than 2000m(6500ft).</p> <p>5. The power supply is considered as an independent unit ,but the final equipment still need to re-confirm that the whole system complies with the EMC directives. For guidance on how to perform these EMC tests, please refer to "EMI testing of component power supplies." (as available on https://www.meanwell.com/Upload/PDF/EMI_statement_en.pdf)</p> <p>※ Product Liability Disclaimer : For detailed information, please refer to https://www.meanwell.com/serviceDisclaimer.aspx</p>						

■ Block Diagram

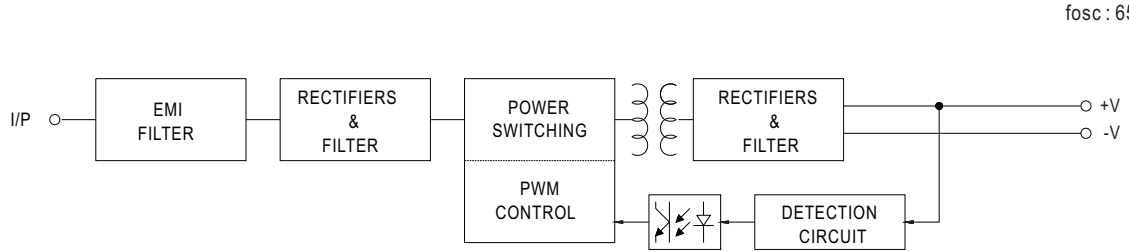

■ Derating Curve

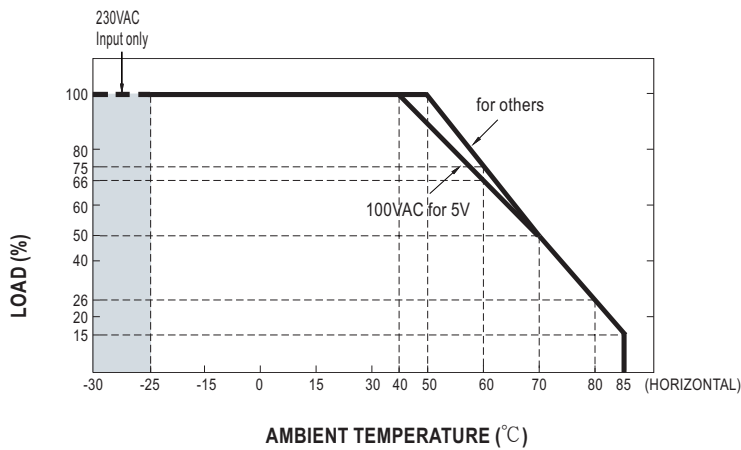

■ Output Derating VS Input Voltage

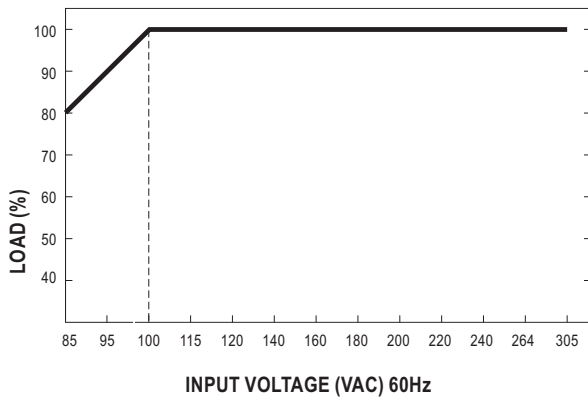

■ Mechanical Specification

Case No. IRM60 Unit:mm

- PCB mounting style (IRM-60)

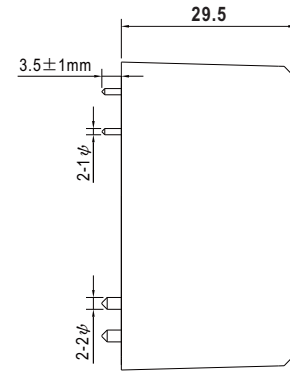
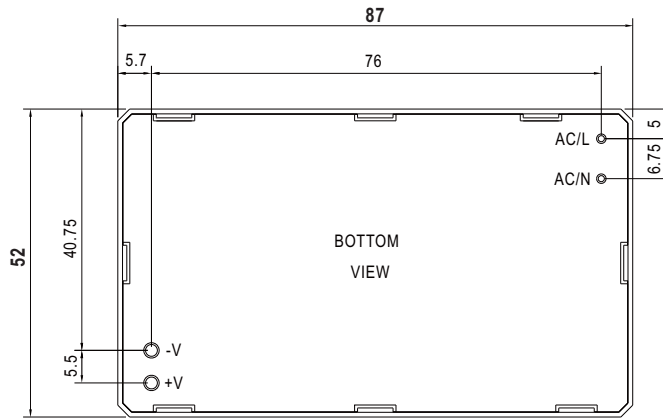

AC/L, AC/N P/N diameter: 1 ϕ
+V, -V P/N diameter: 2 ϕ

- Screw terminal style (IRM-60-xxST)

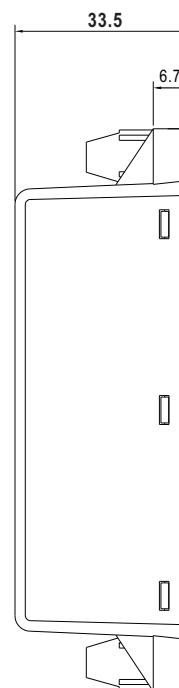
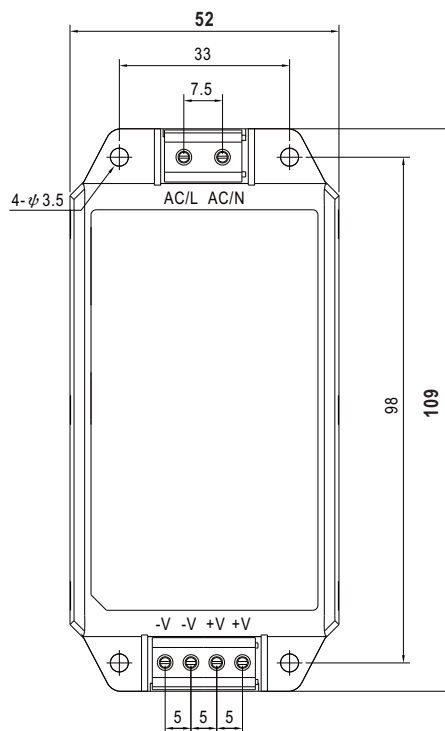

■ Installation Manual

Please refer to : <http://www.meanwell.com/manual.html>