

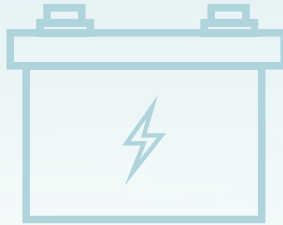

# NPB & NPP Series Installation Manual



## *Intelligent Battery Charger*

• High Reliable Intelligent Battery Charger •

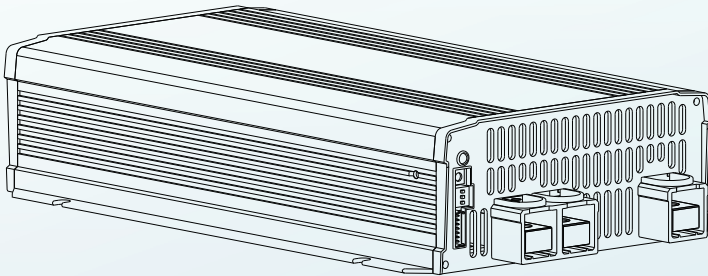

The NPB and NPP series are MEAN WELL's new generation of high-power density smart chargers. The NPB-120/240/360 series adopt a high efficiency hardware design, allowing the products to operate both efficiently and stably. The NPB-450/750/1200/1700 series are fully digital designed products and feature the benefits of miniaturization, high efficiency and intelligence. Being a high efficiency hardware and microprocessor power management design, with four charge curve selection (one programmable and three embedded) and the world's first invention: auto ranging charge, the chargers have the ability to cope with various batteries from different brands, such as lead-acid batteries (flooded, gel and AGM) and li-ion (Lithium iron, lithium manganese), which some may require special charge treatment. Users also can adjust and modify charge parameters (charge voltage/current, cut-off voltage/current...etc.) in each charge stage via the built-in CAN bus interface, some battery protection functions, in addition, may be disabled through the intelligent communication interface. The whole NPP family is equipped with both charger and power supply modes. These two modes can be set freely according to user's demand. In the charger mode, a three-stage charging function is provided, and the charging voltage and current can be adjusted according to different batteries. If it's in the power supply mode, it will be able to driver general loads. The flexible and intelligent design of the NPB and NPP series can provide a perfect solution for complex battery applications.

# Index

<b>1.Safety Guidelines</b>	1	<b>6.Protections and failure correction</b>	55
<b>2.Introduction</b>	2	6.1 Protections	55
2.1 Model number	2	6.2 Failure correction	56
2.2 Features	2	<b>7.Warranty</b>	57
2.3 Main specification	3		
2.4 Safety overview	18		
2.5 Derating curve	19		
2.6 Mechanical specification	20		
<b>3.Installation &amp; Wiring</b>	23		
3.1 Precautions	23		
3.2 Installation procedures	23		
3.3 Cable selection	24		
3.4 Battery selection	24		
3.5 Serial and parallel connection of battery	25		
<b>4.User Interface Panel</b>	26		
4.1 Panel description	26		
4.2 LED indicator	29		
4.3 Pin assignment of (NPB)	30		
4.4 Pin assignment of (NPP)	31		
<b>5.Explanation of setting</b>	32		
5.1 Function difference	32		
5.2 Function Description	32		
5.3 Operating modes (2/3 stage)	37		
5.4 Setting of charging curve	40		
5.5 CANBus protocol	43		

# 1.Safety Guidelines

- 1.1 It is suitable for lead-acid batteries (flooded water type, Gel colloid type, AGM adsorption glass fiber) or (lithium iron, lithium manganese, lithium ternary...etc.)
- 1.2 The charger must be installed in a dry and well ventilated area. It should not be exposed to rain or snow.
- 1.3 All failures should be examined by the qualified technician.
- 1.4 The cables between charger and battery should be kept as short as possible to prevent excessive voltage drop (suggested cable length: 50cm~100cm). Too much voltage drop will lead to longer charging period.
- 1.5 Make sure charging voltage and current meet battery's specification.
- 1.6 Refrain from connecting new and old batteries in series.
- 1.7 Charger should be in the OFF mode before making battery connection or disconnection.
- 1.8 For auto ranging. Please refer to the manual before using this function. And note that, it must work together with battery that built-in BMS.
- 1.9 This equipment is not suitable for use in locations where children are likely to be present.
- 1.10 The protective earthing is used as a safeguard, the instructions shall require connection of the equipment protective earthing conductor to the installation protective earthing conductor (for example, by means of a power cord connected to a socket-outlet with earthing connection).
- 1.11 Indoor use only. 

# 2.Introduction

## 2.1 Model number

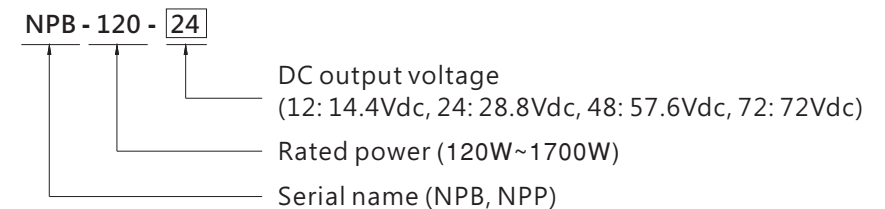

## 2.2 Features

- 2.2.1 It is suitable for lead-acid batteries and lithium iron batteries
- 2.2.2 2 or 3-stage charging curve by DIP S.W.
- 2.2.3 4 charging curves ready to use)only for NPB-450/750/1200/1700)
- 2.2.4 Built-in active PFC function
- 2.2.5 Built-in CANbus protocol for control and monitoring (Only for NPB-450/750/1200/1700)
- 2.2.6 Protections: Short circuit/Over voltage/Over temperature/Battery under voltage and over voltage/Battery reverse polarity)
- 2.2.7 Auto ranging function (Only for NPB-450/750/1200/1700)
- 2.2.8 Both charger mode or power supply can be choose accordingly
- 2.2.9 LED indicator: status/ abnormal indication
- 2.2.10 DEKRA/UL/EAC/CE/UKCA certify
- 2.2.11 3 years warranty

## 2.3 Specification

### NPB-120 series

MODEL	NPB-120-12□			NPB-120-24□		NPB-120-48□		
	□ =XLR,AD1,TB							
OUTPUT	BOOST CHARGE VOLTAGE (Vboost)(default)	14.4V	28.8V	57.6V				
	FLOAT CHARGE VOLTAGE (Vfloat)(default)	13.8V	27.6V	55.2V				
	VOLTAGE ADJUSTABLE RANGE	10.5 ~ 15.2V	21 ~ 30.4V	42 ~ 60.8V				
	OUTPUT CURRENT <small>Note.5</small>	6.8A	4A	2A				
	CURRENT ADJUSTABLE RANGE	50% ~ 100%						
	MAX. POWER <small>Note.3</small>	103.4W	121.6W	121.6W				
	RECOMMENDED BATTERY CAPACITY (AMP HOURS) <small>Note.4</small>	20 ~ 90AH	15 ~ 50AH	7 ~ 25AH				
INPUT	VOLTAGE RANGE <small>Note.5</small>	90 ~ 264VAC 127 ~ 370VDC						
	FREQUENCY RANGE	47 ~ 63Hz						
	POWER FACTOR (Typ.)	PF>0.98/115VAC, PF>0.92/230VAC@12V, PF>0.93/230VAC@24/48V at full load						
	EFFICIENCY (Typ.)	XLR	86.5%	89%	90.5%			
		AD1	86.5%	89%	90.5%			
		TB	87%	89.5%	90.5%			
	AC CURRENT (Typ.)	1.5A/115VAC	0.8A/230VAC					
INRUSH CURRENT (Typ.)	COLD START 55A at 230VAC							
PROTECTION	SHORT CIRCUIT <small>Note.6</small>	Protection type : Constant current limiting, charger will shutdown after 5 sec, re-power on to recover						
	OVER VOLTAGE	16 ~ 20V	32 ~ 40V	64 ~ 75V				
	REVERSE POLARITY	By internal fuse open						
	OVER TEMPERATURE	Shut down O/P voltage, recovers automatically after temperature goes down						
FUNCTION	CHARGING CURVE	2 or 3 stage adjustable by DIP S.W						
ENVIRONMENT	WORK TEMP.	-30 ~ +70°C (Refer to "Derating Curve")						
	WORKING HUMIDITY	20 ~ 95% RH non-condensing						
	STORAGE TEMP., HUMIDITY	-40 ~ +85°C, 10 ~ 95% RH non-condensing						
	TEMP. COEFFICIENT	±0.05%/°C (0 ~ 50°C)						
	VIBRATION	10 ~ 500Hz, 2G 10min./1cycle, 60min. each along X, Y, Z axes						
OTHER	MTBF	631.8K hrs min. Telcordia SR-332(Bellcore) ; 225.8K hrs min. MIL-HDBK-217F (25°C)						
	DIMENSION	180*96*49mm (L*W*H)						
	PACKING	1.3Kg; 10pcs/14Kg/1.13CUFT						

### NPB-240 series

MODEL	NPB-240-12□			NPB-240-24□		NPB-240-48□		
	□ =XLR,AD1,TB							
OUTPUT	BOOST CHARGE VOLTAGE (Vboost)(default)	14.4V	28.8V	57.6V				
	FLOAT CHARGE VOLTAGE (Vfloat)(default)	13.8V	27.6V	55.2V				
	VOLTAGE ADJUSTABLE RANGE	10.5 ~ 15.2V	21 ~ 30.4V	42 ~ 60.8V				
	OUTPUT CURRENT <small>Note.5</small>	13.5A	8A	4A				
	CURRENT ADJUSTABLE RANGE	50% ~ 100%						
	MAX. POWER <small>Note.3</small>	205.2W	243.2W	243.2W				
	RECOMMENDED BATTERY CAPACITY (AMP HOURS) <small>Note.4</small>	55 ~ 180AH	30 ~ 100AH	15 ~ 50AH				
INPUT	VOLTAGE RANGE <small>Note.5</small>	90 ~ 264VAC 127 ~ 370VDC						
	FREQUENCY RANGE	47 ~ 63Hz						
	POWER FACTOR (Typ.)	PF>0.98/115VAC, PF>0.95/230VAC at full load						
	EFFICIENCY (Typ.)	XLR	88.5%	92%	92.5%			
		AD1	88.5%	92%	92.5%			
		TB	89%	92%	93%			
	AC CURRENT (Typ.)	3A/115VAC	1.5A/230VAC					
INRUSH CURRENT (Typ.)	COLD START 50A at 230VAC							
PROTECTION	SHORT CIRCUIT <small>Note.6</small>	Protection type : Constant current limiting, charger will shutdown after 5 sec, re-power on to recover						
	OVER VOLTAGE	16 ~ 20V	32 ~ 40V	64 ~ 75V				
	REVERSE POLARITY	By internal fuse open						
	OVER TEMPERATURE	Shut down O/P voltage, recovers automatically after temperature goes down						
FUNCTION	CHARGING CURVE	2 or 3 stage adjustable by DIP S.W						
ENVIRONMENT	WORK TEMP.	-30 ~ +70°C (Refer to "Derating Curve")						
	WORKING HUMIDITY	20 ~ 95% RH non-condensing						
	STORAGE TEMP., HUMIDITY	-40 ~ +85°C, 10 ~ 95% RH non-condensing						
	TEMP. COEFFICIENT	±0.05%/°C (0 ~ 50°C)						
	VIBRATION	10 ~ 500Hz, 2G 10min./1cycle, 60min. each along X, Y, Z axes						
OTHER	MTBF	428.3K hrs min. Telcordia SR-332(Bellcore) ; 157.5K hrs min. MIL-HDBK-217F (25°C)						
	DIMENSION	180*96*49mm (L*W*H)						
	PACKING	1.3Kg; 10pcs/14Kg/1.13CUFT						

## NPB-360 series

MODEL		NPB-360-12□ □ =XLR,AD1,TB	NPB-360-24□	NPB-360-48□	
OUTPUT	BOOST CHARGE VOLTAGE (Vboost)(default)	14.4V	28.8V	57.6V	
	FLOAT CHARGE VOLTAGE (Vfloat)(default)	13.8V	27.6V	55.2V	
	VOLTAGE ADJUSTABLE RANGE	10.5 ~ 15.2V	21 ~ 30.4V	42 ~ 60.8V	
	OUTPUT CURRENT Note.5	20A	12A	6A	
	CURRENT ADJUSTABLE RANGE	50% ~ 100%			
	MAX. POWER Note.3	304W	364.8W	364.8W	
	RECOMMENDED BATTERY CAPACITY (AMP HOURS) Note.4	65 ~ 195AH	40 ~ 125AH	20 ~ 65AH	
INPUT	VOLTAGE RANGE Note.5	90 ~ 264VAC 127 ~ 370VDC			
	FREQUENCY RANGE	47 ~ 63Hz			
	POWER FACTOR (Typ.)	PF>0.98/115VAC, PF>0.95/230VAC at full load			
	EFFICIENCY (Typ.)	XLR	87%	91%	92%
		AD1	87%	91%	92%
		TB	88.5%	92%	92.5%
	AC CURRENT (Typ.)	4.5A/115VAC 2.2A/230VAC			
INRUSH CURRENT (Typ.)	COLD START 50A at 230VAC				
PROTECTION	SHORT CIRCUIT Note.6	Protection type : Constant current limiting, charger will shutdown after 5 sec, re-power on to recover			
	OVER VOLTAGE	16 ~ 20V	32 ~ 40V	64 ~ 75V	
	REVERSE POLARITY	By internal fuse open			
	OVER TEMPERATURE	Shut down O/P voltage, recovers automatically after temperature goes down			
FUNCTION	CHARGING CURVE	2 or 3 stage adjustable by DIP S.W			
	FAN CONTROL (Typ.)	Internal RTH3 $\geq$ 50°C Fan ON, $\leq$ 45°C Fan OFF			
ENVIRON- MENT	WORK TEMP.	-30 ~ +70°C (Refer to "Derating Curve")			
	WORKING HUMIDITY	20 ~ 95% RH non-condensing			
	STORAGE TEMP., HUMIDITY	-40 ~ +85°C, 10 ~ 95% RH non-condensing			
	TEMP. COEFFICIENT	$\pm$ 0.05%/°C (0 ~ 50°C)			
OTHER	MTBF	434.8K hrs min. Telcordia SR-332(Bellcore); 173.9K hrs min. MIL-HDBK-217F (25°C)			
	DIMENSION	180*96*49mm (L*W*H)			
	PACKING	1.3Kg; 10pcs/14Kg/1.13CUFT			

## NPB-450 series

MODEL		NPB-450-12	NPB-450-24	NPB-450-48	NPB-450-72
OUTPUT	BOOST CHARGE VOLTAGE (Vboost)(default)	14.4V	28.8V	57.6V	72V
	FLOAT CHARGE VOLTAGE (Vfloat)(default)	13.8V	27.6V	55.2V	69V
	CHARGE VOLTAGE RANGE Note.3	10.5 ~ 21V	21 ~ 42V	42 ~ 80V	54 ~ 100V
	MAX. OUTPUT CURRENT (CC) Note.4	25A	13.5A	6.8A	5.5A
	MAX. POWER Note.4	420W	453.6W	456.96W	462W
	RECOMMENDED BATTERY CAPACITY (AMP HOURS) Note.5	90 ~ 300AH	45 ~ 155AH	24 ~ 80AH	19 ~ 64AH
	LEAKAGE CURRENT FROM BATTERY (Typ.)	<1mA			
	INPUT	VOLTAGE RANGE Note.6	90 ~ 264VAC 127 ~ 370VDC		
FREQUENCY RANGE		47 ~ 63Hz			
POWER FACTOR (Typ.)		PF>0.98/115VAC, PF>0.95/230VAC at full load			
EFFICIENCY (Typ.) Note.7		92%	93%	93%	93%
AC CURRENT (Typ.)		4.5A/115VAC 2.2A/230VAC			
INRUSH CURRENT (Typ.)		COLD START 50A at 230VAC			
LEAKAGE CURRENT		<0.75mA/240VAC			
PROTECTION	SHORT CIRCUIT Note.8	Protection type : Constant current limiting, charger will shutdown after 5 sec, re-power on to recover			
	OVER VOLTAGE Note.9	21.5 ~ 26V	43 ~ 52V	82 ~ 100V	102 ~ 120V
	REVERSE POLARITY	Protected internal reverse detection, No damage, re-power on to recover after conduction is removed			
	OVER TEMPERATURE	Shut down O/P voltage, recovers automatically after temperature goes down			
FUNCTION	CHARGING CURVE	2 or 3 stage selectable by back panel DIP S.W, or SBP-001 and computer			
	CHARGING PARAMETERS PROGRAMMABLE	Charging voltage and current can be set with SBP-001 and computer Charging voltage can be adjustable via back panel DIP S.W, Please refer to the manual for more detail			
	AUTO RANGING CHARGING CURVE (Typ.)	Please refer to the manual for more detail Charging current adjustable 50~100% by back panel potentiometer			
	CANBUS INTERFACE	Please refer to the manual			
	CHARGER OK SIGNAL	The TTL signal out, Charger OK = 4.5 ~ 5.5V ; Charger failure or protection = -0.5 ~ 0.5V			
	BATTERY OK SIGNAL	The TTL signal out, Battery full = 4.5 ~ 5.5V ; Charging = -0.5 ~ 0.5V			
	REMOTE CONTROL	Short : Charger normal work Open : Charger stop charging			
TEMPERATURE COMPENSATION	By NTC				
FAN SPEED CONTROL	Depends on internal temperature				
ENVIRON- MENT	WORK TEMP.	-30 ~ +70°C (Refer to "Derating Curve")			
	WORKING HUMIDITY	20 ~ 95% RH non-condensing			
	STORAGE TEMP., HUMIDITY	-40 ~ +85°C, 10 ~ 95% RH non-condensing			
	TEMP. COEFFICIENT	$\pm$ 0.05%/°C (0 ~ 50°C)			
OTHER	VIBRATION	10 ~ 500Hz, 2G 10min./1cycle, 60min. each along X, Y, Z axes			
	MTBF	273.7K hrs min. Telcordia SR-332(Bellcore); 83.4K hrs min. MIL-HDBK-217F (25°C)			
OTHER	DIMENSION	205*135*55mm (L*W*H)			
	PACKING	1.02Kg; 8pcs/10Kg/1.71CUFT			

## NPB-750 series

MODEL		NPB-750-12	NPB-750-24	NPB-750-48
OUTPUT	BOOST CHARGE VOLTAGE (Vboost)(default)	14.4V	28.8V	57.6V
	FLOAT CHARGE VOLTAGE (Vfloat)(default)	13.8V	27.6V	55.2V
	CHARGE VOLTAGE RANGE Note.3	10.5 ~ 21V	21 ~ 42V	42 ~ 80V
	MAX. OUTPUT CURRENT (CC) Note.4	43A	22.5A	11.3A
	MAX. POWER Note.4	722.4W	756W	759.36W
	RECOMMENDED BATTERY CAPACITY (AMP HOURS) Note.5	150 ~ 500AH	80 ~ 260AH	40 ~ 130AH
	LEAKAGE CURRENT FROM BATTERY (Typ.)	<1mA		
INPUT	VOLTAGE RANGE Note.6	90 ~ 264VAC	127 ~ 370VDC	
	FREQUENCY RANGE	47 ~ 63Hz		
	POWER FACTOR (Typ.)	PF>0.98/115VAC, PF>0.95/230VAC at full load		
	EFFICIENCY (Typ.) Note.7	92%	93%	93%
	AC CURRENT (Typ.)	8.7A/115VAC	4A/230VAC	
	INRUSH CURRENT (Typ.)	COLD START 50A at 230VAC		
	LEAKAGE CURRENT	<0.75mA/240VAC		
PROTECTION	SHORT CIRCUIT Note.8	Protection type : Constant current limiting, charger will shutdown after 5 sec, re-power on to recover		
	OVER VOLTAGE Note.9	21.5 ~ 26V	43 ~ 52V	82 ~ 100V
	REVERSE POLARITY	Protected internal reverse detection, No damage, re-power on to recover after conduction is removed		
	OVER TEMPERATURE	Shut down O/P voltage, recovers automatically after temperature goes down		
FUNCTION	CHARGING CURVE	2 or 3 stage selectable by back panel DIP S.W, or SBP-001 and computer		
	CHARGING PARAMETERS PROGRAMMABLE	Charging voltage and current can be set with SBP-001 and computer Charging voltage can be adjustable via back panel DIP S.W, Please refer to the manual for more detail		
	AUTO RANGING CHARGING CURVE (Typ.)	Please refer to the manual for more detail Charging current adjustable 50~100% by back panel potentiometer		
	CANBUS INTERFACE	Please refer to the manual		
	CHARGER OK SIGNAL	The TTL signal out, Charger OK = 4.5 ~ 5.5V ; Charger failure or protection = -0.5 ~ 0.5V		
	BATTERY OK SIGNAL	The TTL signal out, Battery full = 4.5 ~ 5.5V ; Charging = -0.5 ~ 0.5V		
	REMOTE CONTROL	Short : Charger normal work      Open : Charger stop charging		
	TEMPERATURE COMPENSATION	By NTC		
	FAN SPEED CONTROL	Depends on internal temperature		
ENVIRON- MENT	WORK TEMP.	-30 ~ +70°C (Refer to "Derating Curve")		
	WORKING HUMIDITY	20 ~ 95% RH non-condensing		
	STORAGE TEMP., HUMIDITY	-40 ~ +85°C, 10 ~ 95% RH non-condensing		
	TEMP. COEFFICIENT	±0.05%/°C (0 ~ 50°C)		
	VIBRATION	10 ~ 500Hz, 2G 10min./1cycle, 60min. each along X, Y, Z axes		
OTHER	MTBF	227.6K hrs min.    Telcordia SR-332(Bellcore) ; 67.7K hrs min.    MIL-HDBK-217F (25°C)		
	DIMENSION	230*158*67mm (L*W*H)		
	PACKING	1.84Kg; 4pcs/9Kg/1.63CUFT		

## NPB-1200 series

MODEL		NPB-1200-12	NPB-1200-24	NPB-1200-48
OUTPUT	BOOST CHARGE VOLTAGE (Vboost)(default)	14.4V	28.8V	57.6V
	FLOAT CHARGE VOLTAGE (Vfloat)(default)	13.8V	27.6V	55.2V
	CHARGE VOLTAGE RANGE Note.3	10.5 ~ 21V	21 ~ 42V	42 ~ 80V
	MAX. OUTPUT CURRENT (CC) Note.4	70A	36A	18A
	MAX. POWER Note.4	1176W	1209.6W	1209.6W
	RECOMMENDED BATTERY CAPACITY (AMP HOURS) Note.5	240 ~ 800AH	120 ~ 420AH	60 ~ 210AH
	LEAKAGE CURRENT FROM BATTERY (Typ.)	<1mA		
INPUT	VOLTAGE RANGE Note.6	90 ~ 264VAC	127 ~ 370VDC	
	FREQUENCY RANGE	47 ~ 63Hz		
	POWER FACTOR (Typ.)	PF>0.98/115VAC, PF>0.95/230VAC at full load		
	EFFICIENCY (Typ.) Note.7	91%	92%	93%
	AC CURRENT (Typ.)	12A/115VAC	6.5A/230VAC	
	INRUSH CURRENT (Typ.)	COLD START 50A at 230VAC		
	LEAKAGE CURRENT	<0.75mA/240VAC		
PROTECTION	SHORT CIRCUIT Note.8	Protection type : Constant current limiting, charger will shutdown after 5 sec, re-power on to recover		
	OVER VOLTAGE Note.9	21.5 ~ 26V	43 ~ 52V	82 ~ 100V
	REVERSE POLARITY	Protected internal reverse detection, No damage, re-power on to recover after conduction is removed		
	OVER TEMPERATURE	Shut down O/P voltage, recovers automatically after temperature goes down		
FUNCTION	CHARGING CURVE	2 or 3 stage selectable by back panel DIP S.W, or SBP-001 and computer		
	CHARGING PARAMETERS PROGRAMMABLE	Charging voltage and current can be set with SBP-001 and computer Charging voltage can be adjustable via back panel DIP S.W, Please refer to the manual for more detail		
	AUTO RANGING CHARGING CURVE (Typ.)	Please refer to the manual for more detail Charging current adjustable 50~100% by back panel potentiometer		
	CANBUS INTERFACE	Please refer to the manual		
	CHARGER OK SIGNAL	The TTL signal out, Charger OK = 4.5 ~ 5.5V ; Charger failure or protection = -0.5 ~ 0.5V		
	BATTERY OK SIGNAL	The TTL signal out, Battery full = 4.5 ~ 5.5V ; Charging = -0.5 ~ 0.5V		
	REMOTE CONTROL	Short : Charger normal work      Open : Charger stop charging		
	TEMPERATURE COMPENSATION	By NTC		
	FAN SPEED CONTROL	Depends on internal temperature		
ENVIRON- MENT	WORK TEMP.	-30 ~ +70°C (Refer to "Derating Curve")		
	WORKING HUMIDITY	20 ~ 95% RH non-condensing		
	STORAGE TEMP., HUMIDITY	-40 ~ +85°C, 10 ~ 95% RH non-condensing		
	TEMP. COEFFICIENT	±0.05%/°C (0 ~ 50°C)		
	VIBRATION	10 ~ 500Hz, 2G 10min./1cycle, 60min. each along X, Y, Z axes		
OTHER	MTBF	TBD		
	DIMENSION	250*158*67mm (L*W*H)		
	PACKING	TBD		

## NPB-1700 series

MODEL	NPB-1700-12	NPB-1700-24	NPB-1700-48	
OUTPUT	BOOST CHARGE VOLTAGE (Vboost)(default)	14.4V	28.8V	57.6V
	FLOAT CHARGE VOLTAGE (Vfloat)(default)	13.8V	27.6V	55.2V
	CHARGE VOLTAGE RANGE Note.3	10.5 ~ 21V	21 ~ 42V	42 ~ 80V
	MAX. OUTPUT CURRENT (CC) Note.4	85A	50A	25A
	MAX. POWER Note.4	1428W	1680W	1680W
	RECOMMENDED BATTERY CAPACITY (AMP HOURS) Note.5	300 ~ 1000AH	200 ~ 640AH	100 ~ 330AH
	LEAKAGE CURRENT FROM BATTERY (Typ.)	<1mA		
INPUT	VOLTAGE RANGE Note.6	90 ~ 264VAC	127 ~ 370VDC	
	FREQUENCY RANGE	47 ~ 63Hz		
	POWER FACTOR (Typ.)	PF>0.98/115VAC, PF>0.95/230VAC at full load		
	EFFICIENCY (Typ.) Note.7	91%	92%	93%
	AC CURRENT (Typ.)	14.8A/115VAC	9.3A/230VAC	
	INRUSH CURRENT (Typ.)	COLD START 50A at 230VAC		
	LEAKAGE CURRENT	<0.75mA/240VAC		
PROTECTION	SHORT CIRCUIT Note.8	Protection type : Constant current limiting, charger will shutdown after 5 sec, re-power on to recover		
	OVER VOLTAGE Note.9	21.5 ~ 26V	43 ~ 52V	82 ~ 100V
	REVERSE POLARITY	Protected internal reverse detection, No damage, re-power on to recover after conduction is removed		
	OVER TEMPERATURE	Shut down O/P voltage, recovers automatically after temperature goes down		
FUNCTION	CHARGING CURVE	2 or 3 stage selectable by back panel DIP S.W, or SBP-001 and computer		
	CHARGING PARAMETERS PROGRAMMABLE	Charging voltage and current can be set with SBP-001 and computer Charging voltage can be adjustable via back panel DIP S.W, Please refer to the manual for more detail		
	AUTO RANGING CHARGING CURVE (Typ.)	Please refer to the manual for more detail Charging current adjustable 50~100% by back panel potentiometer		
	CANBUS INTERFACE	Please refer to the manual		
	CHARGER OK SIGNAL	The TTL signal out, Charger OK = 4.5 ~ 5.5V ; Charger failure or protection = -0.5 ~ 0.5V		
	BATTERY OK SIGNAL	The TTL signal out, Battery full = 4.5 ~ 5.5V ; Charging = -0.5 ~ 0.5V		
	REMOTE CONTROL	Short : Charger normal work    Open : Charger stop charging		
	TEMPERATURE COMPENSATION	By NTC		
	FAN SPEED CONTROL	Depends on internal temperature		
ENVIRON- MENT	WORK TEMP.	-30 ~ +70°C (Refer to "Derating Curve")		
	WORKING HUMIDITY	20 ~ 95% RH non-condensing		
	STORAGE TEMP., HUMIDITY	-40 ~ +85°C, 10 ~ 95% RH non-condensing		
	TEMP. COEFFICIENT	±0.05%/°C (0 ~ 50°C)		
	VIBRATION	10 ~ 500Hz, 2G 10min./1cycle, 60min. each along X, Y, Z axes		
OTHER	MTBF	TBD		
	DIMENSION	300*184*70mm (L*W*H)		
	PACKING	TBD		

## NPP-450 series-Charger mode(Default)

MODEL	NPP-450-12	NPP-450-24	NPP-450-48	NPP-450-72	
OUTPUT	BOOST CHARGE VOLTAGE (Vboost)(default)	14.4V	28.8V	57.6V	72V
	FLOAT CHARGE VOLTAGE (Vfloat)(default)	13.8V	27.6V	55.2V	69V
	VOLTAGE ADJUSTABLE RANGE	10.5 ~ 21V	21 ~ 42V	42 ~ 80V	54 ~ 100V
	MAX. OUTPUT CURRENT(CC)	By built-in potentiometer			
	CURRENT ADJUSTABLE RANGE	25A	13.5A	6.8A	5.5A
	MAX. POWER	12.5 ~ 25A	6.75 ~ 13.5A	3.4 ~ 6.8A	2.75 ~ 5.5A
	RECOMMENDED BATTERY CAPACITY (AMP HOURS) Note.3	By built-in potentiometer			
INPUT	VOLTAGE RANGE Note.4	90 ~ 264VAC	127 ~ 370VDC		
	FREQUENCY RANGE	47 ~ 63Hz			
	POWER FACTOR (Typ.)	PF>0.98/115VAC, PF>0.95/230VAC at full load			
	EFFICIENCY (Typ.) Note.5	92%	93%	93%	93%
	AC CURRENT (Typ.)	4.5A/115VAC	2.2A/230VAC		
	INRUSH CURRENT (Typ.)	COLD START 50A at 230VAC			
	PROTECTION	SHORT CIRCUIT Note.6	Protection type : Constant current limiting, charger will shutdown after 5 sec, re-power on to recover		
OVER VOLTAGE		21.5 ~ 26V	43 ~ 52V	82 ~ 100V	102 ~ 120V
OVER TEMPERATURE		Protection type : Shut down and latch off o/p voltage, re-power on to recover Shut down O/P voltage, recovers automatically after temperature goes down			
FUNCTION	REMOTE CONTROL	Open : Charger stop charging    Short : Charger normal work			
	CHARGING CURVE	3 stage only			
	CHARGER OK SIGNAL	The TTL signal out, Charger OK = 4.5 ~ 5.5V ; Charger failure or protection = -0.5 ~ 0.5V			
	BATTERY OK SIGNAL	The TTL signal out, Battery full = 4.5 ~ 5.5V ; Charging = -0.5 ~ 0.5V			
ENVIRON- MENT	FAN ON/OFF CONTROL	Depends on internal temperature			
	WORK TEMP.	-30 ~ +70°C (Refer to "Derating Curve")			
	WORKING HUMIDITY	20 ~ 95% RH non-condensing			
	STORAGE TEMP., HUMIDITY	-40 ~ +85°C, 10 ~ 95% RH non-condensing			
	TEMP. COEFFICIENT	±0.05%/°C (0 ~ 50°C)			
OTHER	VIBRATION	10 ~ 500Hz, 2G 10min./1cycle, 60min. each along X, Y, Z axes			
	MTBF	352.3K hrs min.	Telcordia SR-332(Belcore) ; 118.5K hrs min.	MIL-HDBK-217F (25°C)	
	DIMENSION	205*135*55mm (L*W*H)			
PACKING	1.02Kg; 8pcs/10Kg/1.71CUFT				



## NPP-450 series-Power supply mode

MODEL		NPP-450-12	NPP-450-24	NPP-450-48	NPP-450-72
OUTPUT	DC VOLTAGE	14.4V	28.8V	57.6V	72V
	VOLTAGE ADJUSTABLE RANGE	10.5 ~ 21V	21 ~ 42V	42 ~ 80V	54 ~ 100V
		By built-in potentiometer			
	RATED CURRENT	25A	13.5A	6.8A	5.5A
	RATED POWER	420W	453.6W	456.96W	462W
	RIPPLE & NOISE (max.)	180mVp-p	300mVp-p	480mVp-p	600mVp-p
	VOLTAGE TOLERANCE	±1.0%	±1.0%	±1.0%	±1.0%
	LINE REGULATION	±0.5%	±0.5%	±0.5%	±0.5%
	LOAD REGULATION	±1.0%	±1.0%	±0.5%	±0.5%
	SETUP, RISE TIME	1800ms, 60ms/230VAC at full load			
HOLD UP TIME (Typ.)	16ms/230VAC at 75% load 10ms/230VAC at full load				
INPUT	VOLTAGE RANGE <small>Note.3</small>	90 ~ 264VAC	127 ~ 370VDC		
	FREQUENCY RANGE	47 ~ 63Hz			
	POWER FACTOR (Typ.)	PF>0.98/115VAC, PF>0.95/230VAC at full load			
	EFFICIENCY (Typ.) <small>Note.4</small>	92%	93%	93%	93%
	AC CURRENT (Typ.)	4.5A/115VAC	2.2A/230VAC		
	INRUSH CURRENT (Typ.)	COLD START 50A at 230VAC			
PROTECTION	OVERLOAD	100 ~ 110% rated output power Protection type : Constant current limiting, unit will shutdown after 5 sec, re-power on to recover			
	SHORT CIRCUIT <small>Note.5</small>	Protection type : Constant current limiting, charger will shutdown after 5 sec, re-power on to recover			
	OVER VOLTAGE	21.5 ~ 26V	43 ~ 52V	82 ~ 100V	102 ~ 120V
	OVER TEMPERATURE	Protection type : Shut down and latch off o/p voltage, re-power on to recover Shut down O/P voltage, recovers automatically after temperature goes down			
FUNCTION	REMOTE CONTROL	Short : Power ON Open : Power OFF			
	CHARGER OK SIGNAL	The TTL signal out, Charger OK = 4.5 ~ 5.5V ; Charger failure or protection = -0.5 ~ 0.5V			
	FAN ON/OFF CONTROL	Depends on internal temperature			
ENVIRONMENT	WORK TEMP.	-30 ~ +70°C (Refer to "Derating Curve")			
	WORKING HUMIDITY	20 ~ 95% RH non-condensing			
	STORAGE TEMP., HUMIDITY	-40 ~ +85°C, 10 ~ 95% RH non-condensing			
	TEMP. COEFFICIENT	±0.05%/°C (0 ~ 50°C)			
	VIBRATION	10 ~ 500Hz, 2G 10min./1cycle, 60min. each along X, Y, Z axes			
OTHER	MTBF	352.3K hrs min. Telcordia SR-332(Bellcore) ; 118.5K hrs min. MIL-HDBK-217F (25°C)			
	DIMENSION	205*135*55mm (L*W*H)			
	PACKING	1.02Kg; 8pcs/10Kg/1.71CUFT			

## NPP-750 series-Charger mode(Default)

MODEL		NPP-750-12	NPP-750-24	NPP-750-48
OUTPUT	BOOST CHARGE VOLTAGE (Vboost)(default)	14.4V	28.8V	57.6V
	FLOAT CHARGE VOLTAGE (Vfloat)(default)	13.8V	27.6V	55.2V
	VOLTAGE ADJUSTABLE RANGE	10.5 ~ 21V	21 ~ 42V	42 ~ 80V
		By built-in potentiometer		
	MAX. OUTPUT CURRENT(CC)	43A	22.5A	11.3A
	CURRENT ADJUSTABLE RANGE	21.5 ~ 43A	11.25 ~ 22.5A	5.65 ~ 11.3A
		By built-in potentiometer		
	MAX. POWER	722.4W	756W	759.36W
	RECOMMENDED BATTERY CAPACITY (AMP HOURS) <small>Note.3</small>	150 ~ 500AH	80 ~ 260AH	40 ~ 130AH
	INPUT	VOLTAGE RANGE <small>Note.4</small>	90 ~ 264VAC	127 ~ 370VDC
FREQUENCY RANGE		47 ~ 63Hz		
POWER FACTOR (Typ.)		PF>0.98/115VAC, PF>0.95/230VAC at full load		
EFFICIENCY (Typ.) <small>Note.5</small>		90%	91%	92%
AC CURRENT (Typ.)		8.7A/115VAC	4A/230VAC	
INRUSH CURRENT (Typ.)		COLD START 50A at 230VAC		
PROTECTION	SHORT CIRCUIT <small>Note.6</small>	Protection type : Constant current limiting, charger will shutdown after 5 sec, re-power on to recover		
	OVER VOLTAGE	21.5 ~ 26V	43 ~ 52V	82 ~ 100V
	OVER TEMPERATURE	Protection type : Shut down and latch off o/p voltage, re-power on to recover Shut down O/P voltage, recovers automatically after temperature goes down		
FUNCTION	REMOTE CONTROL	Open : Charger stop charging Short : Charger normal work		
	CHARGING CURVE	3 stage only		
	CHARGER OK SIGNAL	The TTL signal out, Charger OK = 4.5 ~ 5.5V ; Charger failure or protection = -0.5 ~ 0.5V		
	BATTERY OK SIGNAL	The TTL signal out, Battery full = 4.5 ~ 5.5V ; Charging = -0.5 ~ 0.5V		
FAN ON/OFF CONTROL	Depends on internal temperature			
ENVIRONMENT	WORK TEMP.	-30 ~ +70°C (Refer to "Derating Curve")		
	WORKING HUMIDITY	20 ~ 95% RH non-condensing		
	STORAGE TEMP., HUMIDITY	-40 ~ +85°C, 10 ~ 95% RH non-condensing		
	TEMP. COEFFICIENT	±0.05%/°C (0 ~ 50°C)		
	VIBRATION	10 ~ 500Hz, 2G 10min./1cycle, 60min. each along X, Y, Z axes		
OTHER	MTBF	294.5K hrs min. Telcordia SR-332(Bellcore) ; 95.7K hrs min. MIL-HDBK-217F (25°C)		
	DIMENSION	230*158*67mm (L*W*H)		
	PACKING	1.84Kg; 4pcs/9Kg/1.63CUFT		

## NPP-750 series-Power supply mode

MODEL		NPP-750-12	NPP-750-24	NPP-750-48
OUTPUT	DC VOLTAGE	14.4V	28.8V	57.6V
	VOLTAGE ADJUSTABLE RANGE	10.5 ~ 21V By built-in potentiometer		
	RATED CURRENT	43A	22.5A	11.3A
	RATED POWER	722.4W	756W	759.36W
	RIPPLE & NOISE (max.)	180mVp-p	300mVp-p	480mVp-p
	VOLTAGE TOLERANCE	±1.0%	±1.0%	±1.0%
	LINE REGULATION	±0.5%	±0.5%	±0.5%
	LOAD REGULATION	±1.0%	±1.0%	±0.5%
	SETUP, RISE TIME	1800ms, 60ms/230VAC at full load		
	HOLD UP TIME (Typ.)	16ms/230VAC at 75% load 10ms/230VAC at full load		
INPUT	VOLTAGE RANGE <small>Note.3</small>	90 ~ 264VAC 127 ~ 370VDC		
	FREQUENCY RANGE	47 ~ 63Hz		
	POWER FACTOR (Typ.)	PF>0.98/115VAC, PF>0.95/230VAC at full load		
	EFFICIENCY (Typ.) <small>Note.4</small>	90%	91%	92%
	AC CURRENT (Typ.)	8.7A/115VAC 4A/230VAC		
	INRUSH CURRENT (Typ.)	COLD START 50A at 230VAC		
PROTECTION	OVERLOAD	100 ~ 110% rated output power Protection type : Constant current limiting, unit will shutdown after 5 sec, re-power on to recover		
	SHORT CIRCUIT <small>Note.5</small>	Protection type : Constant current limiting, charger will shutdown after 5 sec, re-power on to recover		
	OVER VOLTAGE	21.5 ~ 26V	43 ~ 52V	82 ~ 100V
	OVER TEMPERATURE	Protection type : Shut down and latch off o/p voltage, re-power on to recover Shut down O/P voltage, recovers automatically after temperature goes down		
FUNCTION	REMOTE CONTROL	Short : Power ON Open : Power OFF		
	CHARGER OK SIGNAL	The TTL signal out, Charger OK = 4.5 ~ 5.5V ; Charger failure or protection = -0.5 ~ 0.5V		
	FAN ON/OFF CONTROL	Depends on internal temperature		
ENVIRONMENT	WORK TEMP.	-30 ~ +70°C (Refer to "Derating Curve")		
	WORKING HUMIDITY	20 ~ 95% RH non-condensing		
	STORAGE TEMP., HUMIDITY	-40 ~ +85°C, 10 ~ 95% RH non-condensing		
	TEMP. COEFFICIENT	±0.05%/°C (0 ~ 50°C)		
	VIBRATION	10 ~ 500Hz, 2G 10min./1cycle, 60min. each along X, Y, Z axes		
OTHER	MTBF	294.5K hrs min. Telcordia SR-332(Bellcore) ; 95.7K hrs min. MIL-HDBK-217F (25°C)		
	DIMENSION	230*158*67mm (L*W*H)		
	PACKING	1.84Kg; 4pcs/9Kg/1.63CUFT		

## NPP-1200 series-Charger mode(Default)

MODEL		NPP-1200-12	NPP-1200-24	NPP-1200-48
OUTPUT	BOOST CHARGE VOLTAGE (Vboost)(default)	14.4V	28.8V	57.6V
	FLOAT CHARGE VOLTAGE (Vfloat)(default)	13.8V	27.6V	55.2V
	VOLTAGE ADJUSTABLE RANGE	10.5 ~ 21V By built-in potentiometer		
	MAX. OUTPUT CURRENT(CC)	70A	36A	18A
	CURRENT ADJUSTABLE RANGE	35 ~ 70A By built-in potentiometer		
	MAX. POWER	1176W	1209.6W	1209.6W
	RECOMMENDED BATTERY CAPACITY (AMP HOURS) <small>Note.3</small>	240 ~ 800AH	120 ~ 420AH	60 ~ 210AH
	VOLTAGE RANGE <small>Note.4</small>	90 ~ 264VAC 127 ~ 370VDC		
	FREQUENCY RANGE	47 ~ 63Hz		
	POWER FACTOR (Typ.)	PF>0.98/115VAC, PF>0.95/230VAC at full load		
INPUT	EFFICIENCY (Typ.) <small>Note.5</small>	91%	92%	93%
	AC CURRENT (Typ.)	12A/115VAC 6.5A/230VAC		
	INRUSH CURRENT (Typ.)	COLD START 50A at 230VAC		
	PROTECTION	SHORT CIRCUIT <small>Note.6</small>	Protection type : Constant current limiting, charger will shutdown after 5 sec, re-power on to recover	
OVER VOLTAGE		21.5 ~ 26V	43 ~ 52V	82 ~ 100V
OVER TEMPERATURE		Protection type : Shut down and latch off o/p voltage, re-power on to recover Shut down O/P voltage, recovers automatically after temperature goes down		
FUNCTION	REMOTE CONTROL	Open : Charger stop charging Short : Charger normal work		
	CHARGING CURVE	3 stage only		
	CHARGER OK SIGNAL	The TTL signal out, Charger OK = 4.5 ~ 5.5V ; Charger failure or protection = -0.5 ~ 0.5V		
	BATTERY OK SIGNAL	The TTL signal out, Battery full = 4.5 ~ 5.5V ; Charging = -0.5 ~ 0.5V		
ENVIRONMENT	FAN ON/OFF CONTROL	Depends on internal temperature		
	WORK TEMP.	-30 ~ +70°C (Refer to "Derating Curve")		
	WORKING HUMIDITY	20 ~ 95% RH non-condensing		
	STORAGE TEMP., HUMIDITY	-40 ~ +85°C, 10 ~ 95% RH non-condensing		
	TEMP. COEFFICIENT	±0.05%/°C (0 ~ 50°C)		
OTHER	VIBRATION	10 ~ 500Hz, 2G 10min./1cycle, 60min. each along X, Y, Z axes		
	MTBF	TBD		
	DIMENSION	250*158*67mm (L*W*H)		
OTHER	PACKING	TBD		

## NPP-1200 series-Power supply mode

MODEL		NPP-1200-12	NPP-1200-24	NPP-1200-48
OUTPUT	DC VOLTAGE	14.4V	28.8V	57.6V
	VOLTAGE ADJUSTABLE RANGE	10.5 ~ 21V	21 ~ 42V	42 ~ 80V
		By built-in potentiometer		
	RATED CURRENT	70A	36A	18A
	RATED POWER	1176W	1209.6W	1209.6W
	RIPPLE & NOISE (max.)	180mVp-p	300mVp-p	480mVp-p
	VOLTAGE TOLERANCE	±1.0%	±1.0%	±1.0%
	LINE REGULATION	±0.5%	±0.5%	±0.5%
	LOAD REGULATION	±1.0%	±1.0%	±0.5%
	SETUP, RISE TIME	1800ms, 60ms/230VAC at full load		
HOLD UP TIME (Typ.)	16ms/230VAC at 75% load 10ms/230VAC at full load			
INPUT	VOLTAGE RANGE <small>Note.3</small>	90 ~ 264VAC	127 ~ 370VDC	
	FREQUENCY RANGE	47 ~ 63Hz		
	POWER FACTOR (Typ.)	PF>0.98/115VAC, PF>0.95/230VAC at full load		
	EFFICIENCY (Typ.) <small>Note.4</small>	91%	92%	93%
	AC CURRENT (Typ.)	12A/115VAC	6.5A/230VAC	
	INRUSH CURRENT (Typ.)	COLD START 50A at 230VAC		
PROTECTION	OVERLOAD	100 ~ 110% rated output power Protection type : Constant current limiting, unit will shutdown after 5 sec, re-power on to recover		
	SHORT CIRCUIT <small>Note.5</small>	Protection type : Constant current limiting, charger will shutdown after 5 sec, re-power on to recover		
	OVER VOLTAGE	21.5 ~ 26V	43 ~ 52V	82 ~ 100V
		Protection type : Shut down and latch off o/p voltage, re-power on to recover		
OVER TEMPERATURE	Shut down O/P voltage, recovers automatically after temperature goes down			
FUNCTION	REMOTE CONTROL	Short : Power ON Open : Power OFF		
	CHARGER OK SIGNAL	The TTL signal out, Charger OK = 4.5 ~ 5.5V ; Charger failure or protection = -0.5 ~ 0.5V		
	FAN ON/OFF CONTROL	Depends on internal temperature		
ENVIRON- MENT	WORK TEMP.	-30 ~ +70°C (Refer to "Derating Curve")		
	WORKING HUMIDITY	20 ~ 95% RH non-condensing		
	STORAGE TEMP., HUMIDITY	-40 ~ +85°C, 10 ~ 95% RH non-condensing		
	TEMP. COEFFICIENT	±0.05%/°C (0 ~ 50°C)		
	VIBRATION	10 ~ 500Hz, 2G 10min./1cycle, 60min. each along X, Y, Z axes		
OTHER	MTBF	TBD		
	DIMENSION	250*158*67mm (L*W*H)		
	PACKING	TBD		

## NPP-1700 series-Charger mode(Default)













MODEL		NPP-1700-12	NPP-1700-24	NPP-1700-48
OUTPUT	BOOST CHARGE VOLTAGE (Vboost)(default)	14.4V	28.8V	57.6V
	FLOAT CHARGE VOLTAGE (Vfloat)(default)	13.8V	27.6V	55.2V
	VOLTAGE ADJUSTABLE RANGE	10.5 ~ 21V	21 ~ 42V	42 ~ 80V
		By built-in potentiometer		
	MAX. OUTPUT CURRENT(CC)	85A	50A	25A
	CURRENT ADJUSTABLE RANGE	42.5 ~ 85A	25 ~ 50A	12.5 ~ 2.5A
		By built-in potentiometer		
	MAX. POWER	1428W	1680W	1680W
	RECOMMENDED BATTERY CAPACITY (AMP HOURS) <small>Note.3</small>	300 ~ 1000AH	200 ~ 640AH	100 ~ 330AH
	INPUT	VOLTAGE RANGE <small>Note.4</small>	90 ~ 264VAC	127 ~ 370VDC
FREQUENCY RANGE		47 ~ 63Hz		
POWER FACTOR (Typ.)		PF>0.98/115VAC, PF>0.95/230VAC at full load		
EFFICIENCY (Typ.) <small>Note.5</small>		91%	92%	93%
AC CURRENT (Typ.)		14.8A/115VAC	9.3A/230VAC	
INRUSH CURRENT (Typ.)		COLD START 50A at 230VAC		
PROTECTION	SHORT CIRCUIT <small>Note.6</small>	Protection type : Constant current limiting, charger will shutdown after 5 sec, re-power on to recover		
	OVER VOLTAGE	21.5 ~ 26V	43 ~ 52V	82 ~ 100V
		Protection type : Shut down and latch off o/p voltage, re-power on to recover		
OVER TEMPERATURE	Shut down O/P voltage, recovers automatically after temperature goes down			
FUNCTION	REMOTE CONTROL	Open : Charger stop charging Short : Charger normal work		
	CHARGING CURVE	3 stage only		
	CHARGER OK SIGNAL	The TTL signal out, Charger OK = 4.5 ~ 5.5V ; Charger failure or protection = -0.5 ~ 0.5V		
	BATTERY OK SIGNAL	The TTL signal out, Battery full = 4.5 ~ 5.5V ; Charging = -0.5 ~ 0.5V		
FAN ON/OFF CONTROL	Depends on internal temperature			
ENVIRON- MENT	WORK TEMP.	-30 ~ +70°C (Refer to "Derating Curve")		
	WORKING HUMIDITY	20 ~ 95% RH non-condensing		
	STORAGE TEMP., HUMIDITY	-40 ~ +85°C, 10 ~ 95% RH non-condensing		
	TEMP. COEFFICIENT	±0.05%/°C (0 ~ 50°C)		
	VIBRATION	10 ~ 500Hz, 2G 10min./1cycle, 60min. each along X, Y, Z axes		
OTHER	MTBF	TBD		
	DIMENSION	300*184*70mm (L*W*H)		
	PACKING	TBD		

## NPP-1700 series-Power supply mode

MODEL	NPP-1700-12	NPP-1700-24	NPP-1700-48	
OUTPUT	DC VOLTAGE	14.4V	28.8V	57.6V
	VOLTAGE ADJUSTABLE RANGE	10.5 ~ 21V	21 ~ 42V	42 ~ 80V
		By built-in potentiometer		
	RATED CURRENT	85A	50A	25A
	RATED POWER	1428W	1680W	1680W
	RIPPLE & NOISE (max.)	180mVp-p	300mVp-p	480mVp-p
	VOLTAGE TOLERANCE	±1.0%	±1.0%	±1.0%
	LINE REGULATION	±0.5%	±0.5%	±0.5%
	LOAD REGULATION	±1.0%	±1.0%	±0.5%
	SETUP, RISE TIME	1800ms, 60ms/230VAC at full load		
HOLD UP TIME (Typ.)	16ms/230VAC at 75% load	10ms/230VAC at full load		
INPUT	VOLTAGE RANGE <small>Note.3</small>	90 ~ 264VAC	127 ~ 370VDC	
	FREQUENCY RANGE	47 ~ 63Hz		
	POWER FACTOR (Typ.)	PF>0.98/115VAC, PF>0.95/230VAC at full load		
	EFFICIENCY (Typ.) <small>Note.4</small>	91%	92%	93%
	AC CURRENT (Typ.)	14.8A/115VAC	9.3A/230VAC	
	INRUSH CURRENT (Typ.)	COLD START 50A at 230VAC		
PROTECTION	OVERLOAD	100 ~ 110% rated output power Protection type : Constant current limiting, unit will shutdown after 5 sec, re-power on to recover		
	SHORT CIRCUIT <small>Note.5</small>	Protection type : Constant current limiting, charger will shutdown after 5 sec, re-power on to recover		
	OVER VOLTAGE	21.5 ~ 26V	43 ~ 52V	82 ~ 100V
		Protection type : Shut down and latch off o/p voltage, re-power on to recover		
	OVER TEMPERATURE	Shut down O/P voltage, recovers automatically after temperature goes down		
FUNCTION	REMOTE CONTROL	Short : Power ON    Open : Power OFF		
	CHARGER OK SIGNAL	The TTL signal out, Charger OK = 4.5 ~ 5.5V ; Charger failure or protection = -0.5 ~ 0.5V		
	FAN ON/OFF CONTROL	Depends on internal temperature		
ENVIRONMENT	WORK TEMP.	-30 ~ +70°C (Refer to "Derating Curve")		
	WORKING HUMIDITY	20 ~ 95% RH non-condensing		
	STORAGE TEMP., HUMIDITY	-40 ~ +85°C, 10 ~ 95% RH non-condensing		
	TEMP. COEFFICIENT	±0.05%/°C (0 ~ 50°C)		
	VIBRATION	10 ~ 500Hz, 2G 10min./1cycle, 60min. each along X, Y, Z axes		
OTHER	MTBF	TBD		
	DIMENSION	300*184*70mm (L*W*H)		
	PACKING	TBD		

\*For the detail of NOTE information, please refer to the specification on official website.

## 2.4 Safety Overview

Model	Safety
NPB-120	     IEC62368-1 IEC60335-1/2-29    BS EN/EN62368-1    TPTC004 BS EN/EN60335-1/2-29
NPB-360	  UL62368-1 (for TB: 12/24/48V and XLR/AD1:48V)    (for XLR/AD1: 12 / 24V)
NPB-240	     IEC62368-1 IEC60335-1/2-29    BS EN/EN62368-1    TPTC004 BS EN/EN60335-1/2-29
NPB/NPP-450	
NPB/NPP-750	
NPB/NPP-1200	 UL62368-1
NPB/NPP-1700	

Note : For instruction of EN60335-1/2-29

- 2.4.1 This product is a built-in battery charger and is planned to be installed in caravans and other similar vehicles. This product can charge at least one cell rechargeable lead-acid or lithium-ion battery or one battery pack. When charging more rechargeable lead-acid or lithium-ion batteries or battery packs, please refer to the recommended capacity in this manual. It is recommended that the capacity does not exceed the maximum battery capacity recommended in this manual. Do not charge non-rechargeable batteries.
- 2.4.2 The battery terminal not connected to the chassis has to be connected first. The other connection is to be made to the chassis, remote from the battery and fuel line. The battery charger is then to be connected to the supply mains.
- 2.4.3 After charging, disconnect the battery charger from the supply mains. Then remove the chassis connection and then the battery connection.
- 2.4.4 The connection to the supply mains is to be in accordance with the national wiring.
- 2.4.5 The appliance is not to be used by persons (including children) with reduced physical, sensory or mental capabilities, or lack of experience and knowledge, unless they have been given supervision or instruction.
- 2.4.6 Children being supervised not to play with the appliance.
- 2.4.7 Connection of the appliance to the supply mains and the interconnection of any separate components.
- 2.4.8 Necessity to allow disconnection of the appliance from the supply after installation.

## 2.5 Derating curve

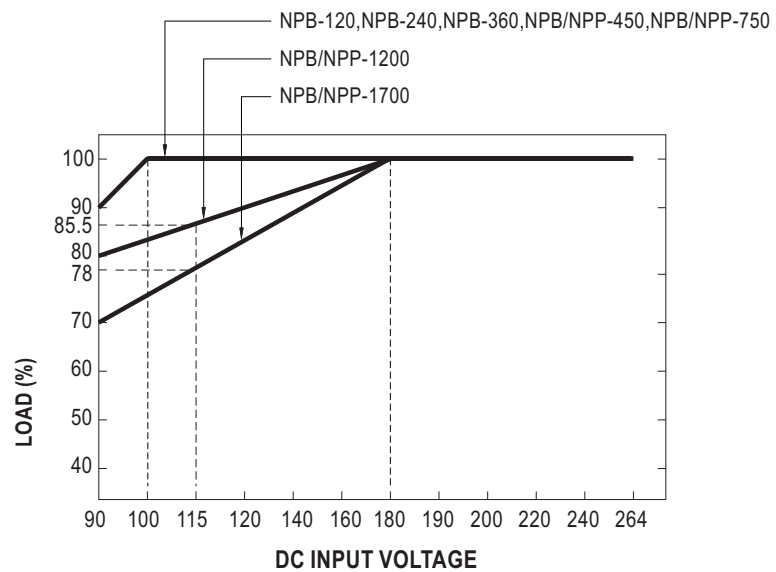
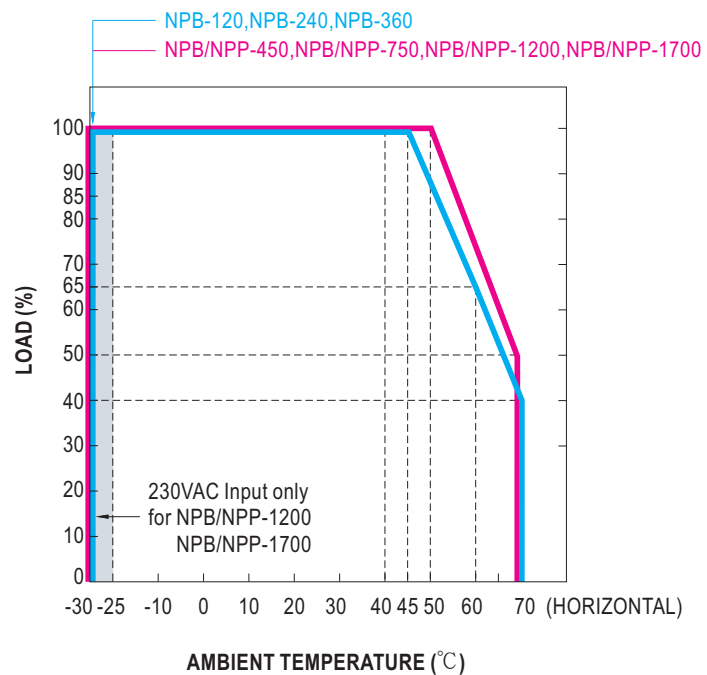

## 2.6 Mechanical specification

### NPB-120/240/360

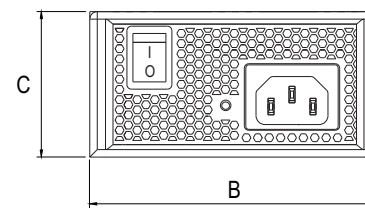
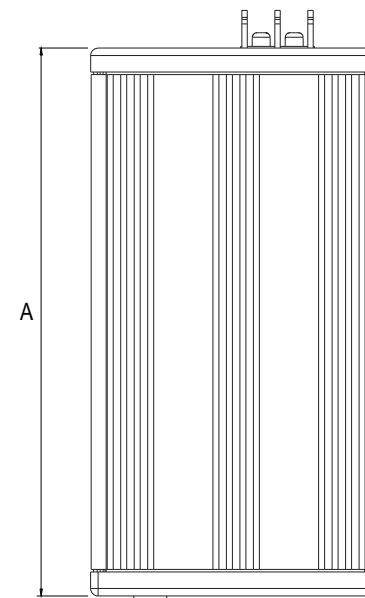

Model	A	B	C
NPB-120	180	96	49
NPB-240	180	96	49
NPB-360	180	96	49

Unit:mm

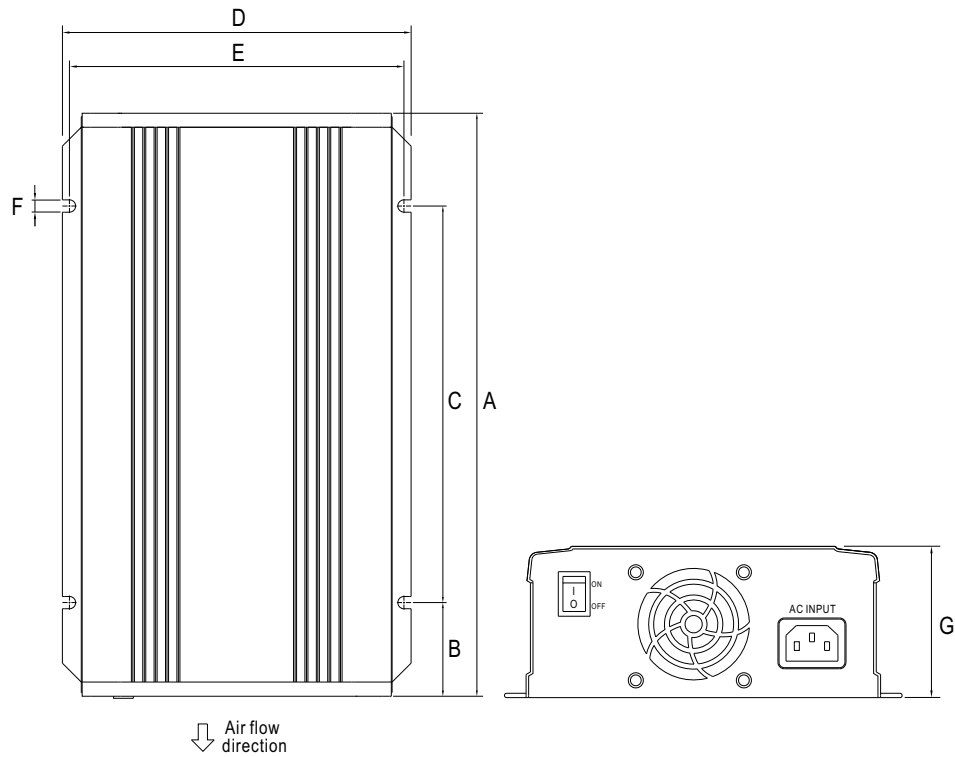

# NPB/NPP-450/750/1200/1700



Model	A	B	C	D	E	F	G
NPB/NPP-450	205	39	127	135	121	5.5	55
NPB/NPP-750	230	42.5	145	158	147	7	67
NPB/NPP-1200	250	47.5	155	158	147	7	67
NPB/NPP-1700	300	72.5	155	184	173	7	70

Unit:mm

# Accessories(NPB/NPP-450/750/1200/1700)

MW's Order No.	Item		Quantity
CARRY HANDLE	①	Pull Handle 	1
	②	Foot pad 	4
	③	Screw 	2

① Pull Handle

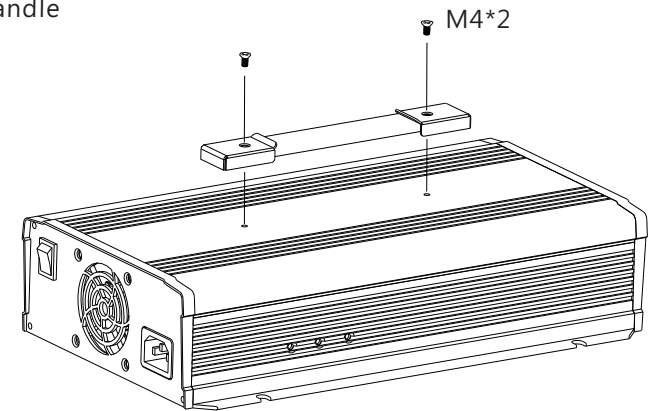

② Foot pad

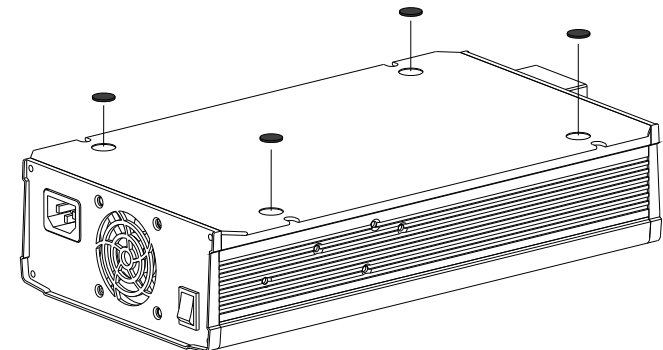

### 3.Installation & Wiring

#### 3.1 Precautions

- Please do not install in places with high moisture or near water.
- Please make sure the ventilation is not blocked with force air cooling models. We recommend that there should be no barriers within 15cm of the ventilating slits, which is shown as follow.

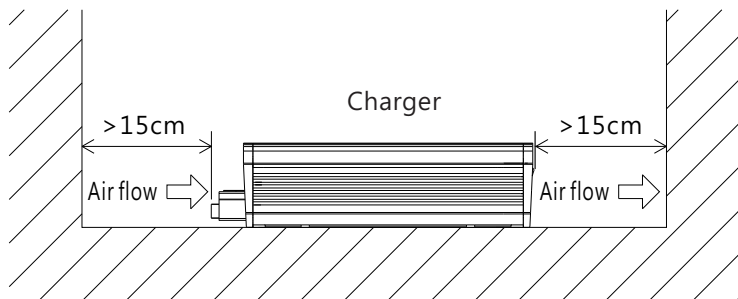
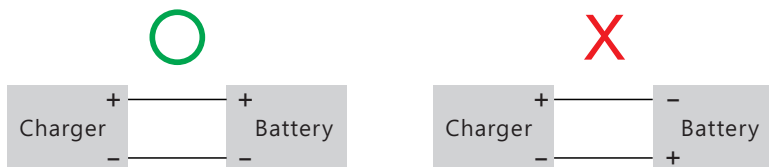

Figure 3-1 set-up recommendation

#### 3.2 Installation procedures

- ① Please turn off the charger first.
- ② Select proper cable for connection between battery and charger by referring to section 3.3
- ③ Connect the positive polarity of battery to the positive of charger, and connect the negative polarity of battery to the negative of charger.



- ④ Turn the power switch to "ON" position. If LED show in GREEN, it states that the unit is in either charging or normal operation. Please refer to chapter 4.2 for detail explanation of LED indication.

#### 3.3 Cable selection

Wire connections should be as short as possible and less than 1 meter is highly recommended. Make sure that suitable wires are chosen based on safety requirement and rating of current. Small cross section will result in lower efficiency, less output power and the wires may also become overheated and cause danger. For selection, please refer to table 3-1.

AWG	Cross-section Area(mm <sup>2</sup> )	Maximum Current(A) UL1015(600V 105°C)
18	0.8	6
16	1.3	8
14	2.1	12
12	3.3	22
10	5.3	35
7	10	46
6	16	60
4	25	80
2	43	110

Table 3-1 Recommendations for the use of wires

#### 3.4 Battery selection

Battery types: Lead acid or lithium ion batteries

Battery capacity: Please refer to the following table

Models	Battery capacity recommendation			
	12V model	24V model	48V model	72V model
NPB-120	20-90AH	15-50AH	7-25AH	NA
NPB-240	55-180AH	30-100AH	15-50AH	
NPB-360	65-195AH	40-125AH	20-65AH	
NPB/NPP-450	90-300AH	45-155AH	24-80AH	19-64AH
NPB/NPP-750	150-500AH	80-260AH	40-130AH	NA
NPB/NPP-1200	240-800AH	120-420AH	60-210AH	
NPB/NPP-1700	300-1000AH	200-640AH	100-330AH	

NOTE :

- 1.Using batteries with greater capacity than recommendation will not damage the battery, but extend charging period is expected.
- 2.Please contact battery supplier for charging characteristics if it's not clear.

### 3.5 Serial and parallel connection of battery

- Serial connection: When connect 2 batteries in series, it doubled the output voltage, but the capacity remains. Ex: 2pcs of 12V 100AH in series, become a 24V 100AH battery.

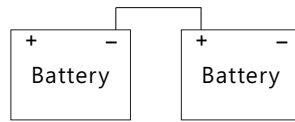

- Parallel connection: When 2 batteries connected in parallel, output voltage remains, but the capacity will double. Ex: 2pcs of 12V 100AH connect in parallel, become a 12V 200AH battery.

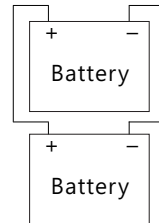

## 4. User Interface Panel

### 4.1 Panel description

- Ⓐ **Power switch :**  
The charger will turn on if the power switch is in ON position. And it will turn off if it's in OFF position.
- Ⓑ **AC input**
- Ⓒ **LED indicator:**  
To show the status of unit.
- Ⓓ **DIP switch :**  
It is used for charging curve selection. Please refer to chapter 5.2 for detail.
- Ⓔ **Control Pin:**  
It is used for control and monitoring function. Please refer to chapter 4.3 and 4.4.
- Ⓕ **Io ADJ:**  
For output current setting.
- Ⓖ **Vo ADJ:**  
For output voltage setting.
- Ⓗ **Ventilations slits :**  
These ventilation slits achieved well ventilation to ensure the durability of the unit.
- Ⓘ **Terminal for battery connection.**

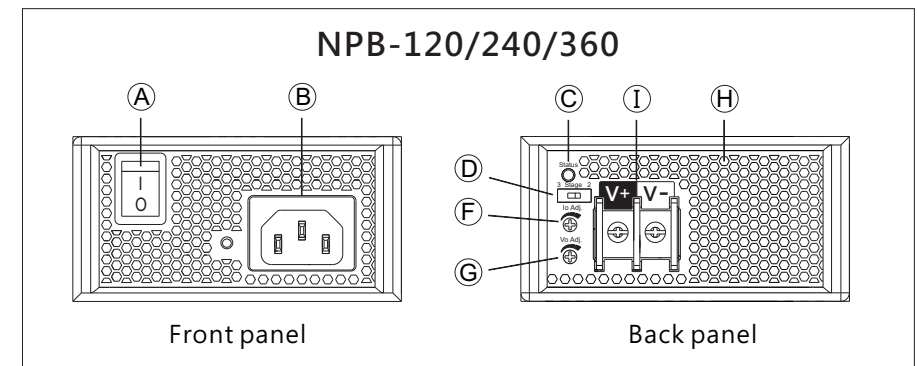



### NPB-450

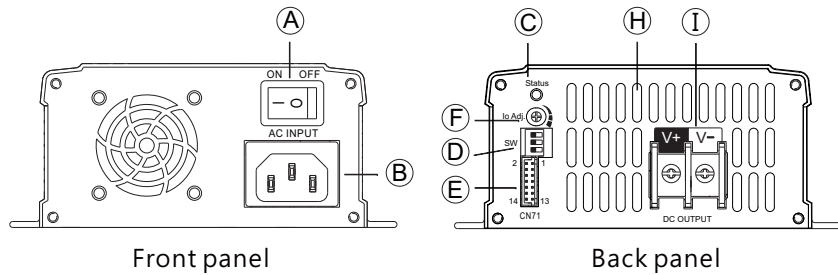

Front panel

Back panel

### NPP-450

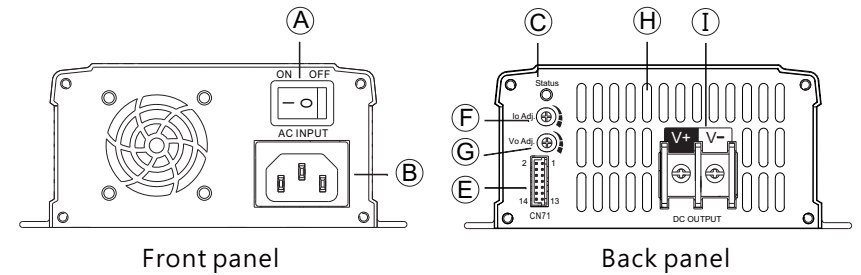

Front panel

Back panel

### NPB-750/1200

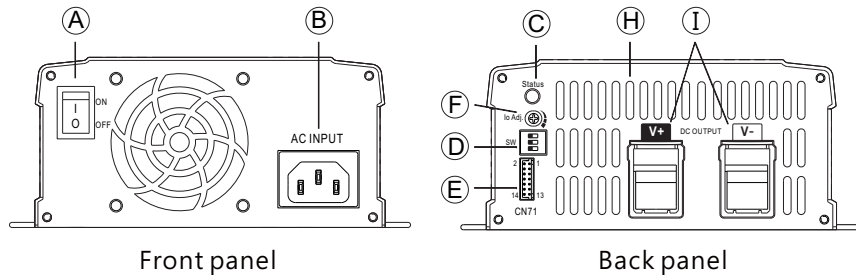

Front panel

Back panel

### NPP-750/1200

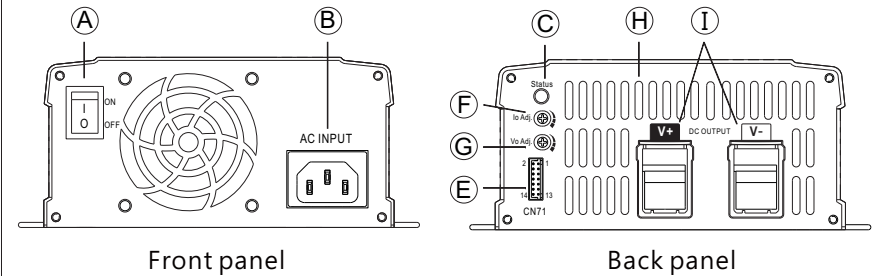

Front panel

Back panel

### NPB-1700

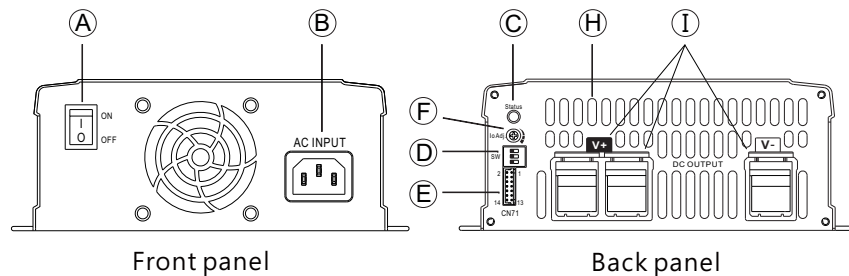

Front panel

Back panel

### NPP-1700

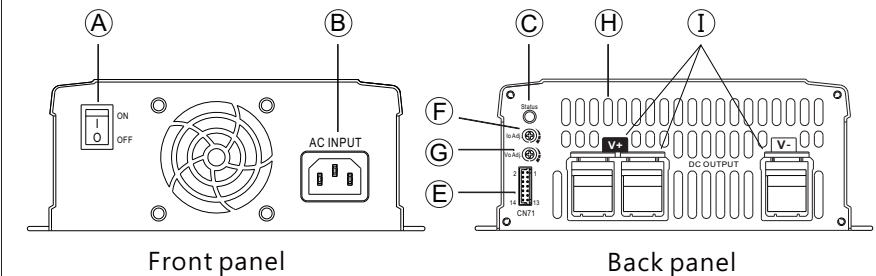

Front panel

Back panel

## 4.2 LED Indicator

NPB series model	LED Indicator	Status
NPB-120 NPB-240 NPB-360	● Green	Float stage(stage 3)or fully charged
	● Red	Charging(stage 1or stage 2)
	○ No Light	Abnormal
NPB-450 NPB-750 NPB-1200 NPB-1700	● Green	Float stage(stage 3)or fully charged
	● Orange	Charging(stage 1or stage 2)
	☀ Orange (Flashing)	Charging with auto ranging function
	● Red	Abnormal(OTP,OVP,short circuit, reverse polarity, time out )
	☀ Red (Flashing)	Unit over heated internally

NPP series model	Charger(Default)	
NPP-450 NPP-750 NPP-1200 NPP-1700	LED Indicator	Status
	● Green	Float stage(stage 3)or fully charged
	● Red	Charging(stage 1or stage 2)
	○ No Light	Abnormal
	Power supply mode	
	LED Indicator	Status
	● Green	Normal working
○ No Light	Abnormal	

## 4.3 Pin assignment of(NPB-450/750/1200/1700)

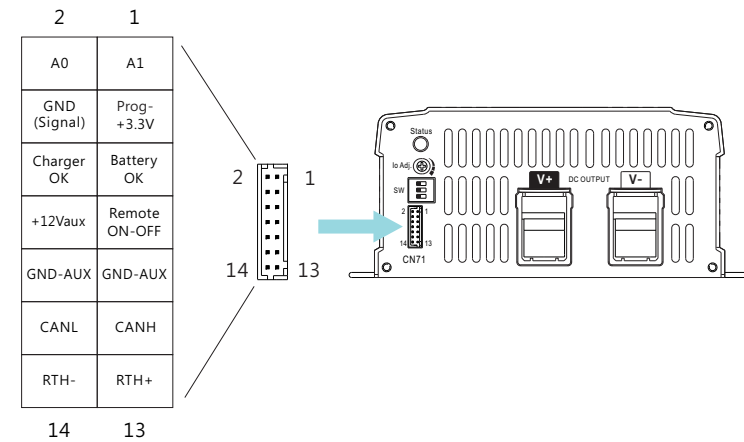

Pin No.	Function	Description
1	A1	CANBus interface address line(A1). Referenced to GND(Signal) Pin4.(Note.1)
2	A0	CANBus interface address line(A0). Referenced to GND(Signal) Pin4.(Note.1)
3	Prog- +3.3V	For programmer +3.3V.
4	GND(Signal)	CANBus interface address lines GND.
5	Battery OK	Battery OK Signal, referenced to GND-AUX(Pin 9 & 10).The Signal is a TTL level signal. The maximum sourcing current is 10mA and only for output(Note.2). Low (-0.5 ~ 0.5V) : When the battery is charging. High (4.5 ~ 5.5V) : When the battery is full.
6	Charger OK	Charger OK Signal, referenced to GND-AUX(Pin 9 & 10).The Signal is a TTL level signal. The maximum sourcing current is 10mA and only for output(Note.2). Low (-0.5 ~ 0.5V) : When the charger fails or the protect function is activating. High (4.5 ~ 5.5V) : When the charger is working properly.
7	Remote ON/OFF	Remote charger ON/OFF Function. The charger can turn the output ON/OFF by dry contact between Remote ON-OFF and +12V-AUX(Note.2). Short (10.8 ~ 13.2V) : Charger ON ; Open (-0.5 ~ 0.5V) : Charger OFF ; The maximum input voltage is 13.2V.
8	+12Vaux	It is controlled by the Remote ON-OFF control.
9,10	GND-AUX	The signal return is isolated from the output terminal. (+V & -V)
11	CANH	For CANBus model: Data line used in CANBus interface. (Note.2).
12	CANL	For CANBus model: Data line used in CANBus interface. (Note.2).
13	RTH+	Temperature sensor(NTC, 5KOhm) comes along with the charger can be connected to the unit to allow temperature compensation of the charging voltage for lead-acid batteries.
14	RTH-	

Note1: Non-isolated signal, referenced to [GND(signal)].

Note2: Isolated signal, referenced to GND-AUX.

## 4.4 Pin assignment of(NPP-450/750/1200/1700)

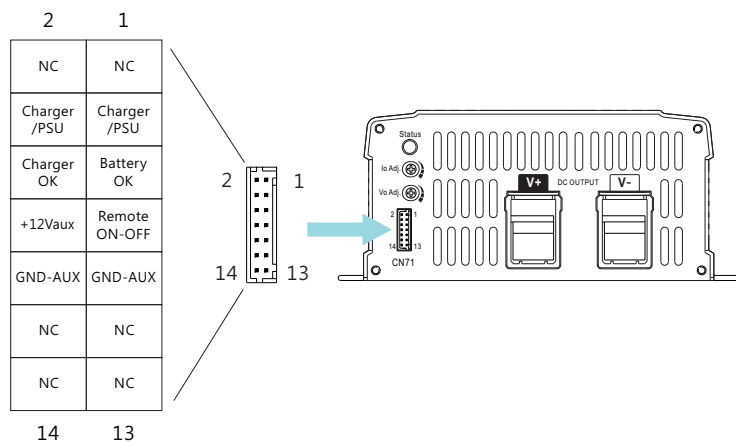

Pin No.	Function	Description
1,2, 11~14	NC	-----
3,4	Charger/ PSU	Open: Battery charger, Color of LED loading indicator: Reference to chapter 4.2. Short: Power supply, Color of LED loading indicator: Green.
5	Battery OK	Battery OK Signal, referenced to GND-AUX(Pin 9 & 10).The Signal is a TTL level signal. The maximum sourcing current is 10mA and only for output(Note). Low (-0.5 ~ 0.5V) : When the battery is charging. High (4.5 ~ 5.5V) : When the battery is full.
6	Charger OK	Charger OK Signal, referenced to GND-AUX(Pin 9 & 10).The Signal is a TTL level signal. The maximum sourcing current is 10mA and only for output (Note). Low (-0.5 ~ 0.5V) : When the charger fails or the protect function is activating. High (4.5 ~ 5.5V) : When the charger is working properly.
7	Remote ON/OFF	Remote charger ON/OFF Function. The charger can turn the output ON/OFF by dry contact between Remote ON-OFF and +12V-AUX(Note). Short (10.8 ~ 13.2V) : Charger ON ; Open (-0.5 ~ 0.5V) : Charger OFF ; The maximum input voltage is 13.2V.
8	+12Vaux	It is controlled by the Remote ON-OFF control.
9,10	GND-AUX	The signal return is isolated from the output terminal. (+V & -V)

Note: Isolated signal, referenced to GND-AUX

## 5.Explanation of setting

### 5.1 Function difference

	NPB-120/240/360	NPB-450/750/1200/1700	NPP series
LED Indication	Red/Green/None	Red/orange/None	Red/Green/None
2/3 stage charging(DIP S.W.)	2/3	2/3	3
Preset charging curve(DIP S.W.)	X	●	X
Programmable charging curve(SBP-001)	X	●	X
Current/voltage adjustment	●	X	●
CANBus protocol	X	●	X
Switch between charger mode and power supply mode	X	X	●
Auto ranging function	X	●	X
Remote ON/OFF	X	●	●
Reverse polarity protection	●	●	X
Charger OK signal	X	●	●
Fully charged OK signal	X	●	●
Temperature compensation	X	● (3 stage only)	X

### 5.2 Function Description

#### 5.2.1 Explanation of DIP switch(NPB only)

- The NPB series is equipped with a DIP switch, which can be used to switch between 2-stage or 3-stage.
- For NPB-450/750/1200/1700, the dip switch not only can be used to switch the number of charging stages, but also choose between 4 preset charging curves. For details, please refer to chapter 5.3 and 5.4.

NPB-120/240/360(Default set as 3 stage)

※ Switch

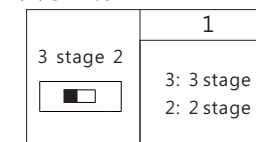

NPB-450/750/1200/1700 (Default set as 3 stage, Default programmable)

※ DIP Switch

	1	2	3	Description
	OFF: 3 stage ON: 2 stage	OFF	OFF	Default, programmable
		ON	OFF	Pre-defined, Gel battery
		OFF	ON	Pre-defined, flooded battery
ON		ON	Pre-defined, AGM battery, LiFeO4	

5.2.2 Charger mode/ power supply modes switching(NPP only)

Use this function to set the working mode of the NPP series.

- Charger mode: can be used to charge the battery.
- Power supply mode: can be used directly with general loads.

Between PIN3 and PIN4	Modes
Open	Charger
Short	Power supply

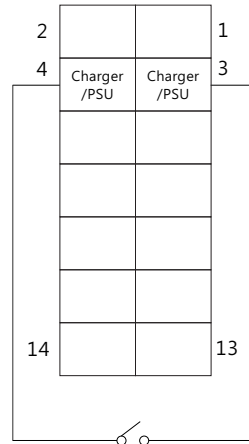

5.2.3 Remote ON/OFF(NPB/NPP-450/750/1200/1700)

By using the DIP switch to change the operation status.

Between PIN 7 and PIN 8	Charger
Short	Remote ON
Open	Remote OFF

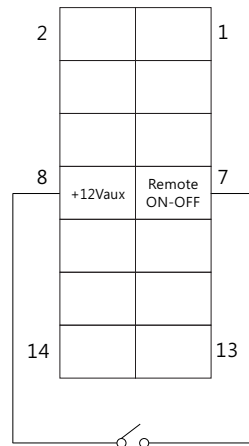

5.2.4 Charger OK signal(NPB/NPP-450/750/1200/1700)

Charger OK signal is a TTL level signal. The maximum sourcing current is 10mA.

Charger OK signal	Charger status
"High" : 4.5 ~ 5.5V	Work normally
"Low" : -0.5 ~ 0.5V	Failure or protection function activated

NOTE: GND-AUX could be either PIN9 or PIN10

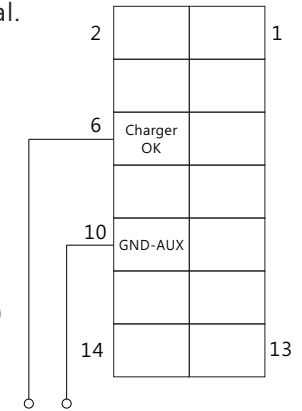

5.2.5 Battery OK signal(NPB/NPP-450/750/1200/1700)

TTL signal is used for battery OK, with maximum of 10mA.

Battery OK signal	Charger status
"High" : 4.5 ~ 5.5V	Charging completed
"Low" : -0.5 ~ 0.5V	Charging

NOTE: GND-AUX could be either PIN9 or PIN10

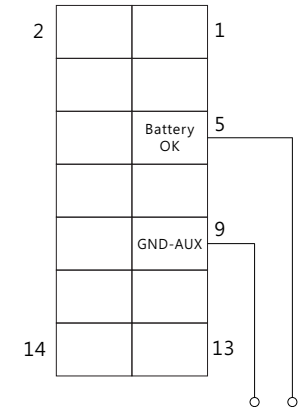

### 5.2.6 Temperature compensation(NPB-450/750/1200/1700)

- The RTH that comes with the products, can be connected to the battery for sensing the temperature of battery. **The charge is able to work normally without the sensor RTH.**
- The parameter is default as -3mV/°C /Cell, with the NTC NSG05C250J5-500V the comes with the product, and connect to RTH+ /RTH- panel.

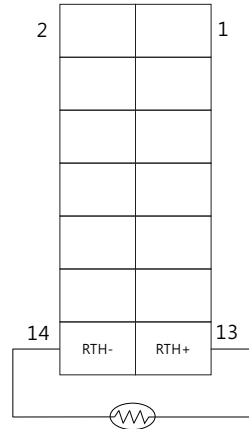

Model	Upper limit of voltage compensation	Lower limit of voltage compensation	Compensation range of Temperature
12V	15.3V	13.2V	0 ~ 40°C
24V	30.6V	26.4V	
48V	61.2V	52.8V	
72V (NPB-450 only)	76.5V	66V	

#### NOTE:

- 1.If the necessary parameter is different from factory setting, SBP-001 or CANbus shall be used to correct the parameter.
- 2.The compensation will only activate during stage 3.

### 5.2.7 Auto ranging function(NPB-450/750/1200/1700)

- The MCU built-in charger will calculate the configuration and parameter of the battery pack and finish the charging sequence automatically. Through the auto ranging function, users can easily finish charging sequence without setting charging curves.

#### ⚠ Caution :

NPB-450/750/1200/1700 Covers 3 different charging voltage range : 10.5V–21V(12V Model);21V–42V(24V Model); 42V– 80V(48V Model) · 54–100V(72V Model · NPB-450 only)Li-ion battery could be dangerous if wrong voltage or sequence is applied. Ex: One battery possess 14.6V as highest charging voltage, NPB-xxx-12 is suitable in this case. **Please ensure that auto ranging function only work with lithium batteries with BMS function.**

### Setting of auto ranging function

NPB-450/750/1200/1700 are preset with charging curves, when intent to activate auto ranging function, Procedures below must be follow:

- ① ALL DIP switch for charging curve setting are switch to OFF position before applying AC main.
- ② Applying AC main under remote OFF condition
- ③ Switch the DIP switch from all OFF to all ON, and then again, back to all OFF in 15 seconds.
- ④ If LED flashes in GREEN for 3 times, it means the setting is succeeded.
- ⑤ Remote ON the unit, and it's now in auto ranging mode.

#### NOTE:

- 1.Auto ranging function only suitable to work with lithium battery with BMS.
- 2.Temperature compensation function is not supported when using auto ranging function.
- 3.Under auto ranging mode, user is not allow to choose 2 or 3 stage charging curve, but Io ADJ can be used to adjust suitable charging current if needed.(default: 100%) ·
- 4.If there is anything unclear, please contact with MEAN WELL or authorized distributor.

### 5.2.8 Back to factory setting

To reset the unit back to factory setting, unit must switch the DIP switch for charging curve under remote OFF condition. Detail procedures are as follow :

- ① ALL DIP switch for charging curve setting are switch to ON position before applying AC main.
- ② Applying AC main under remote OFF condition.
- ③ Switch the DIP switch from all ON to all OFF, and then again, back to all ON in 15 seconds.
- ④ If LED flashes in GREEN for 3 times, it means the setting is succeeded.
- ⑤ Remote ON the unit, and it's now back to factory setting.

### 5.2.9 FAN control

NPB-360/NPP-450/750/1200/1700: FAN will turn ON/OFF based on the internal temperature.

NPB-450/750/1200/1700: FAN will spin under different speed according to the temperature differences.

## 5.3 Operating modes(2/3 stage)

NPB adopts both 2 and 3 stage charging curves for selection, but NPP only possess 3<sup>rd</sup> stage charging curve. 2 stage is for easy and fast charging. 3rd stage will turn off after first 2 stages of charging finished. Users can choose between 2 or 3 stage according to the demand.

### 5.3.1 2 stage charging(DIP switch turn to 2 stage)

In the initial stage of charging, the charger charges the battery with the maximum current, and the fan is ON (built-in fan model). After a period of time (depending on the battery capacity), the charging current gradually decreases. When the charging current drops to 10% of the rated current. LED indicator lights up in green, indicating that the charging process is complete.

NPB-450/750/1200/1700 will turn off the output after the end of the 2-stage charging, on the contract NPB-120/240/360 will continue to work under 3<sup>rd</sup> stage.

### NPB-120/240/360 2 stage charging curve

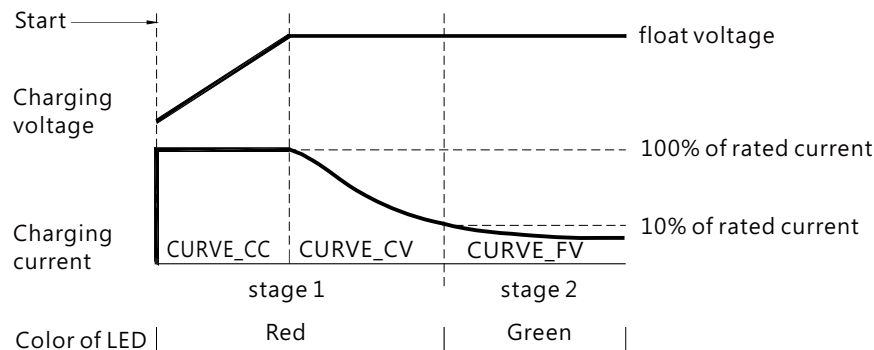

### NPB-450/750/1200/1700 2 stage charging curve

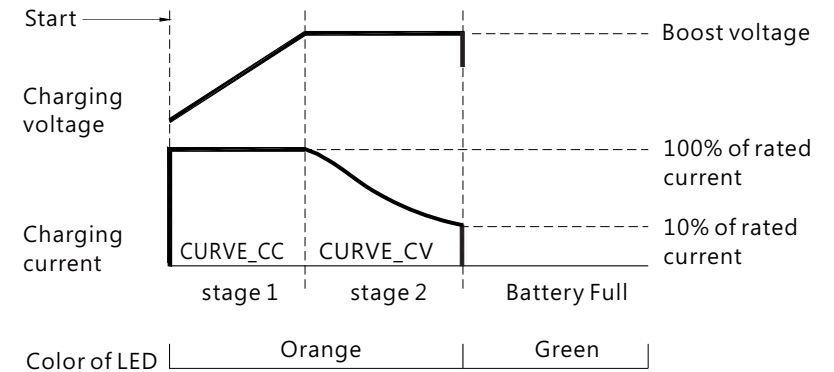

State	12V model	24V model	48V model	72V model
NPB-120 Constant Current	6.8A	4A	2A	NA
NPB-240 Constant Current	13.5A	8A	4A	
NPB-360 Constant Current	20A	12A	6A	
NPB-450 Constant Current	25A	13.5A	6.8A	5.5A
NPB-750 Constant Current	43A	22.5A	11.3A	NA
NPB-1200 Constant Current	70A	36A	18A	
NPB-1700 Constant Current	85A	50A	25A	
Boost voltage	14.4V	28.8V	57.6V	72V

Figure 5.1 Embedded 2 stage charging curve(Default)

### Explanation of 2 stage charging curve

#### ① Initial stage (battery analysis):

Charger will detect and determine if the battery is properly connected, is it connected reversely? or is it already fully charged?

\* Only with NPB-450/750/1200/1700 series.

#### ② Stage 1(Constant current):

High constant current is applied for fast charging, until the voltage of battery reaches to boost voltage.

#### ③ Stage 2( Constant voltage):

In this stage, charger apply a constant voltage on battery. Charging current gradually decrease, and shut down when charging current reach 10% of rated current.

\* Suitable for lead-acid batteries, such as flooded water type, Gel colloid type, AGM adsorption glass fiber. Or, lithium battery, such as lithium iron, lithium manganese, lithium ternary.

\* NPB-120/240/360 remain floating charging after 2<sup>nd</sup> stage charging is finished.

### 5.3.2 3 stage charging(DIP switch turn to 3 stage

In the initial stage of charging, the charger charges the battery with the maximum current, and the fan is ON (built-in fan model). After a period of time (depending on the battery capacity), the charging current gradually decreases. When the charging current drops to 10% of the rated current. LED indicator lights up green, indicating that the charging is complete. And the charger remains float charging stage.

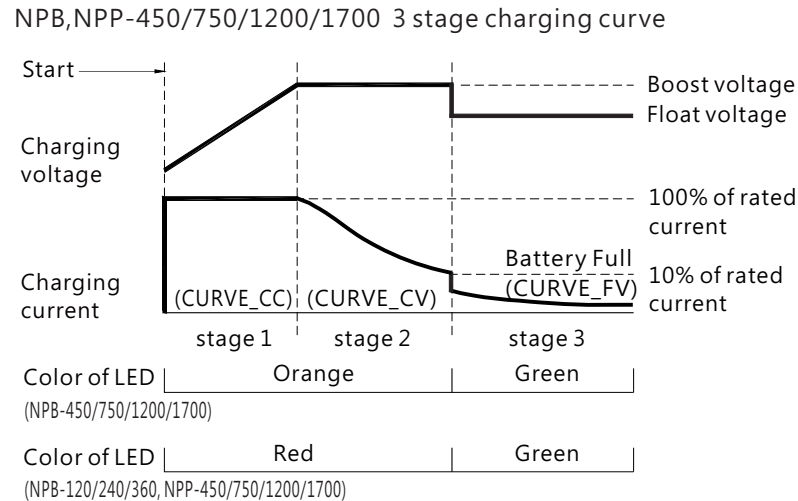

State	12V model	24V model	48V model	72V model
NPB-120 Constant Current	6.8A	4A	2A	NA
NPB-240 Constant Current	13.5A	8A	4A	
NPB-360 Constant Current	20A	12A	6A	
NPB/NPP-450 Constant Current	25A	13.5A	6.8A	5.5A
NPB/NPP-750 Constant Current	43A	22.5A	11.3A	NA
NPB/NPP-1200 Constant Current	70A	36A	18A	
NPB/NPP-1700 Constant Current	85A	50A	25A	
Boost voltage	14.4V	28.8V	57.6V	72V
Float voltage	13.8V	27.6V	55.2V	69V

Figure5. 2 3 stage charging curve(Default)

### Explanation of 3 stage charging curve

- ① Initial stage (battery analysis) :  
Charger will detect and determine if the battery is properly connected, is it connected reversely or it is already fully charged.  
\* only with NPB-450/750/1200/1700 series.
- ② Stage 1(Constant current) :  
High constant current is applied for fast charging, until the voltage of battery reaches to boost voltage.
- ③ Stage 2( Constant voltage) :  
In this stage, charger apply a constant voltage on battery. Charging current gradually decrease, and shut down when charging current reach 10% of rated current.
- ④ Stage 3(Float charging) :  
The charger is able to provide a float voltage after 2 stage charging, in order to keep the battery fully charged at all times. Especially suitable for lead-acid batteries.  
\* Suitable for lead-acid batteries (flooded water type, Gel colloid type, AGM adsorption glass fiber) .

## 5.4 Setting of charging curve(NPB-450/750/1200/1700)

### 5.4.1 Charging curve setting through DIP switch.

The charging curve can be adjusted through the DIP switch on the panel. By following the chart below, there are both 2 and 3 stage charging curves that can be choose accordingly.



### Built-in 2 stage charging curves

DIP S.W position			12V model					
1	2	3	Description	CC (default)				Vboost
ON	OFF	OFF	Default, programmable	25A NPB-450	43A NPB-750	70A NPB-1200	85A NPB-1700	14.4
ON	ON	OFF	Pre-defined, gel batter					14.0
ON	OFF	ON	Pre-defined, flooded battery					14.2
ON	ON	ON	Pre-defined, AGM battery,LiFe04					14.6
DIP S.W position			24V model					
1	2	3	Description	CC (default)				Vboost
ON	OFF	OFF	Default, programmable	13.5A NPB-450	22.5A NPB-750	36A NPB-1200	50A NPB-1700	28.8
ON	ON	OFF	Pre-defined, gel batter					28.0
ON	OFF	ON	Pre-defined, flooded battery					28.4
ON	ON	ON	Pre-defined, AGM battery,LiFe04					29.2

DIP S.W position			48V model				Vboost	
1	2	3	Description	CC (default)				
ON	OFF	OFF	Default, programmable	6.8A NPB-450	11.3A NPB-750	18A NPB-1200	25A NPB-1700	57.6
ON	ON	OFF	Pre-defined, gel batter					56.0
ON	OFF	ON	Pre-defined, flooded battery					56.8
ON	ON	ON	Pre-defined, AGM battery, LiFe04					58.4
DIP S.W position			72V model				Vboost	
1	2	3	Description	CC (default)				
ON	OFF	OFF	Default, programmable	5.5A NPB-450	NA	NA	NA	72
ON	ON	OFF	Pre-defined, gel batter					70
ON	OFF	ON	Pre-defined, flooded battery					71
ON	ON	ON	Pre-defined, AGM battery, LiFe04					73

NOTE : Voltage tolerance of  $\pm 2\%$

### Built-in 3 stage charging curves

DIP S.W position			12V model				Vboost	Vfloat	
1	2	3	Description	CC (default)					
OFF	OFF	OFF	Default, programmable	25A NPB-450	43A NPB-750	70A NPB-1200	85A NPB-1700	14.4	13.8
OFF	ON	OFF	Pre-defined, gel batter					14.0	13.6
OFF	OFF	ON	Pre-defined, flooded battery					14.2	13.4
OFF	ON	ON	Pre-defined, AGM battery, LiFe04					14.6	14.0
DIP S.W position			24V model				Vboost	Vfloat	
1	2	3	Description	CC (default)					
OFF	OFF	OFF	Default, programmable	13.5A NPB-450	22.5A NPB-750	36A NPB-1200	50A NPB-1700	28.8	27.6
OFF	ON	OFF	Pre-defined, gel batter					28.0	27.2
OFF	OFF	ON	Pre-defined, flooded battery					28.4	26.8
OFF	ON	ON	Pre-defined, AGM battery, LiFe04					29.2	28.0
DIP S.W position			48V model				Vboost	Vfloat	
1	2	3	Description	CC (default)					
OFF	OFF	OFF	Default, programmable	6.8A NPB-450	11.3A NPB-750	18A NPB-1200	25A NPB-1700	57.6	55.2
OFF	ON	OFF	Pre-defined, gel batter					56.0	54.4
OFF	OFF	ON	Pre-defined, flooded battery					56.8	53.6
OFF	ON	ON	Pre-defined, AGM battery, LiFe04					58.4	56.0
DIP S.W position			72V model				Vboost	Vfloat	
1	2	3	Description	CC (default)					
OFF	OFF	OFF	Default, programmable	5.5A NPB-450	NA	NA	NA	72	69
OFF	ON	OFF	Pre-defined, gel batter					70	68
OFF	OFF	ON	Pre-defined, flooded battery					71	67
OFF	ON	ON	Pre-defined, AGM battery, LiFe04					73	70

NOTE : Voltage tolerance of  $\pm 2\%$

### 5.4.2 Smart charging curve programming

SBP-001 is a smart battery charging programmer developed by MEAN WELL, which can set the charging curves of the NPB series through editing software. SBP-001 provides functions such as charging curve adjustment and battery temperature compensation. Please set the DIP switch pin to Default, programmable (PIN2: OFF; PIN3: OFF) before use. Take NPB-1200 as an example, install configuration and software interface are shown as below. Please refer to "SBP-001 Smart Battery Charging Programmer User Manual" for details.

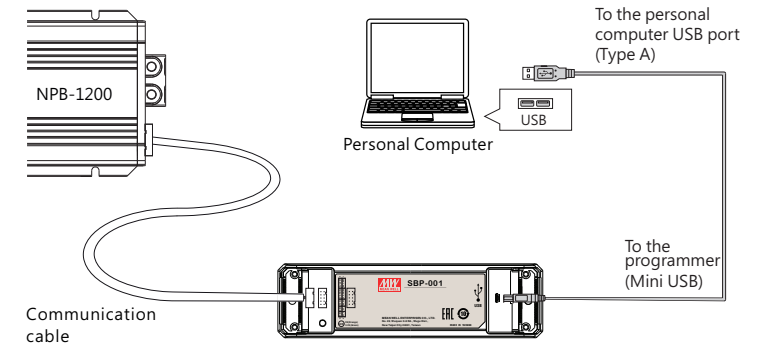

User Interface :

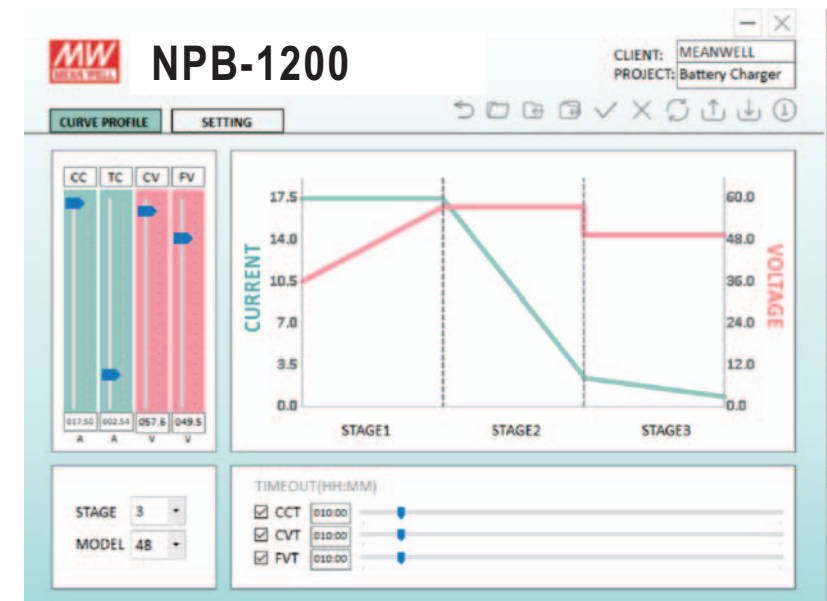



## 5.5 CANBus Protocol(NPB-450/750/1200/1700)

With CANBus protocol, control and monitoring function can be realized. It is helpful when users intent to modify the parameters remotely. Users can access to the master and modify the parameters through CANBus, which include, ON/OFF, output voltage/current, temperature. More to that, users can even change the charging curve parameters, such as constant current level, boost voltage, float voltage and timeout function. For detail, please refer to following chapter.

### 5.5.1 CANBus specifications

- Physical layer specification

This protocol follows CAN ISO-11898 with Baud rate of 250Kbps.

- Data frame

This protocol uses Extended CAN 29-bit identifier frame format or CAN 2.0B.

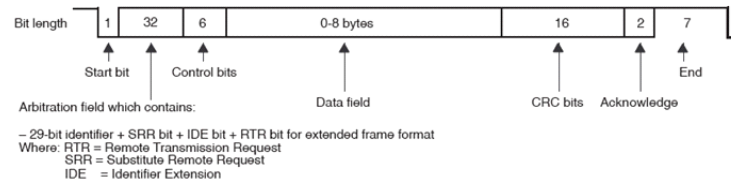

- Communication Timing

Min. request period (Controller to PSU/CHG): 20mSec ◦

Max. response time (PSU/CHG to Controller): 5mSec ◦

Min. packet margin time (Controller to PSU/CHG): 5mSec ◦

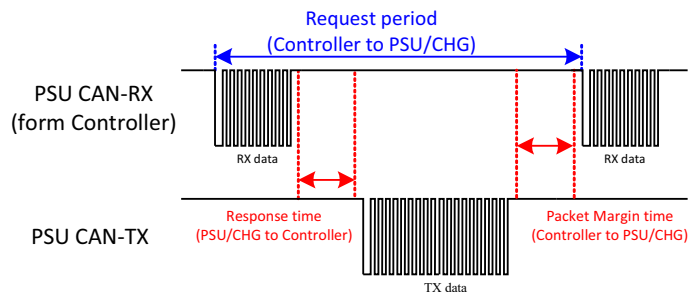

### 5.5.2 CANBus address setting

- When using CANBus, each charger must equip with unique address for individuals. A0~A1 of CN71 is used to define the address(with maximum of 4 address), together with GND(Pin 4).

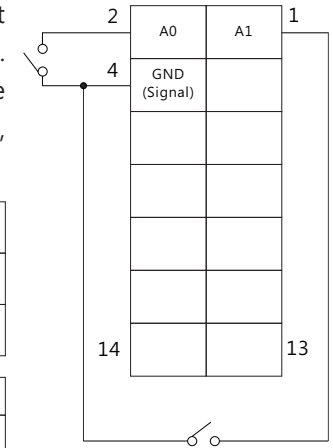

Between A0/A1 and GND(Single)	logic
Open	1
Short	0

Device No.	Device address	
	A1	A0
0	0	0
1	0	1
2	1	0
3	1	1

### 5.5.3 CANBus commend list

Command Code	Command Name	Transaction Type	# of data Bytes	Description
0x0000	OPERATION	R/W	1	ON/OFF control
0x0020	VOUT_SET	R/W	2	Output voltage setting (format: value, F=0.01)
0x0030	IOUT_SET	R/W	2	Output current setting (format: value, F=0.01)
0x0040	FAULT_STATUS	R	2	Abnormal status
0x0050	READ_VIN (NPB-450/750 Does not support)	R	2	Input voltage read value (format: value, F=0.1)
0x0060	READ_VOUT	R	2	Output voltage read value (format: value, F=0.01)
0x0061	READ_IOUT	R	2	Output current read value (format: value, F=0.01)
0x0062	READ_TEMPERATURE_1	R	2	Internal ambient temperature (format: value, F=0.1)

Command Code	Command Name	Transaction Type	# of data Bytes	Description
0x0080	MFR_ID_B0B5	R	6	Manufacturer's name
0x0081	MFR_ID_B6B11	R	6	Manufacturer's name
0x0082	MFR_MODEL_B0B5	R	6	Manufacturer's model name
0x0083	MFR_MODEL_B6B11	R	6	Manufacturer's model name
0x0084	MFR_REVISION_B0B5	R	6	Firmware revision
0x0085	MFR_LOCATION_B0B2	R/W	3	Manufacturer's factory location
0x0086	MFR_DATE_B0B5	R/W	6	Manufacturer date
0x0087	MFR_SERIAL_B0B5	R/W	6	Product serial number
0x0088	MFR_SERIAL_B6B11	R/W	6	Product serial number
0x00B0	CURVE_CC	R/W	2	Constant current setting of charge curve (format: value, F=0.01)
0x00B1	CURVE_CV	R/W	2	Constant voltage setting of charge curve (format: value, F=0.01)
0x00B2	CURVE_FV	R/W	2	Floating voltage setting of charge curve (format: value, F=0.01)
0x00B3	CURVE_TC	R/W	2	Taper current setting value of charging curve (format: value, F=0.01)
0x00B4	CURVE_CONFIG	R/W	2	Configuration setting of charge curve
0x00B5	CURVE_CC_TIMEOUT	R/W	2	CC charge timeout setting of charging curve
0x00B6	CURVE_CV_TIMEOUT	R/W	2	CV charge timeout setting of charging curve
0x00B7	CURVE_FV_TIMEOUT	R/W	2	FV charge timeout setting of charging curve
0x00B8	CHG_STATUS	R	2	Charging status reporting
0x00C0	SCALING_FACTOR	R	2	Scaling ratio
0x00C1	SYSTEM_STATUS	R	2	System status
0x00C2	SYSTEM_CONFIG	R/W	2	System configuration

Message ID definition :

Description	Message ID
Charger to controller message ID	0x000C00XX
Controller to charger message ID	0x000C01XX
Controller broadcasts to charger message ID	0x000C01FF

NOTE : XX means the address of NPB-450/750/1200/1700(which can be assigned by the A0~A1 of the CN71, from range 0x00~0x03)

FAULT\_STATUS:

Low byte	Bit7	Bit6	Bit5	Bit4	Bit3	Bit2	Bit1	Bit0
Definition	HI_TEMP	OP_OFF	AC_FAIL	SHORT	OLP	OVP	OTP	---

Bit 1 OTP: Over temperature protection

0 = Internal temperature normal

1 = Internal temperature abnormal

Bit 2 OVP: Output over voltage protection

0 = Output voltage normal

1 = Output voltage protected

Bit 3 OLP: Output over current protection

0 = Output current normal

1 = Output current protected

Bit 4 SHORT: Output short circuit protection

0 = Shorted circuit do not exist

1 = Output shorted circuit protected

Bit 5 AC\_FAIL: AC abnormal flag

0 = AC main normal

1 = AC abnormal protection

Bit6 OP\_OFF: Output status

0 = Output turned on

1 = Output turned off

Bit7 HI\_TEMP: Internal high temperature protection

0 = Internal temperature normal

1 = Internal temperature abnormal

### CHG\_STATUS :

Low byte	Bit7	Bit6	Bit5	Bit4	Bit3	Bit2	Bit1	Bit0
High byte	FVTOF	CVTOF	CCTOF	---	BTNC	NTCER	---	---
Low byte	---	---	---	---	FVM	CVM	CCM	FULLM

#### Low byte

Bit 0 FULLM : Fully charged status

0 = Not fully charged

1 = Fully charged

Bit 1 CCM : Constant current mode status

0 = The charger NOT in constant current mode

1 = The charger in constant current mode

Bit 2 CVM : Constant voltage mode status

0 = The charge NOT in constant voltage mode

1 = The charge in constant voltage mode

Bit 3 FVM : Float mode status

0 = The charger NOT in float mode

1 = The charger in float mode

Bit 2 NTCER : Temperature compensation status

0 = NO short-circuit in the circuitry of temperature compensation

1 = The circuitry of temperature compensation has short-circuited

Bit 3 BTNC : Battery detection

0 = Battery detected

1 = No battery detected

Bit 5 CCTOF : Time out flag of constant current mode

0 = NO time out in constant current mode

1 = Constant current mode time out

Bit 6 CVTOF : Time out flag of constant voltage mode

0 = NO time out in constant voltage mode

1 = Constant voltage mode time out

Bit 7 FVTOF : Time out flag of float mode

0 = NO time out in float mode

1 = Float mode timed out

### SYSTEM\_STATUS:

Low byte	Bit7	Bit6	Bit5	Bit4	Bit3	Bit2	Bit1	Bit0
Definition	---	EEPER	INITIAL_STATE	---	---	---	DC_OK	---

#### Low byte

Bit 1 DC\_OK: The DC output status

0 = DC output at a normal range

1 = DC output too low

Bit 5 INITIAL\_STATE: Initial stage indication

0 = The unit NOT in an initial state

1 = The unit in an initial state

BIT 6 EEPER: EEPROM access Error

0 = EEPROM accessing normally

1 = EEPROM access error

NOTE: EEPER: When EEPROM access error · the supply stops working and the LED indicator turns off. The supply need to re-power on to recover after the error condition is removed.

### CURVE\_CONFIG(Only available under charger mode):

High byte	Bit15	Bit14	Bit13	Bit12	Bit11	Bit10	Bit9	Bit8
Definition	---	---	---	---	---	FVTOE	CVTOE	CCTOE
Low byte	Bit7	Bit6	Bit5	Bit4	Bit3	Bit2	Bit1	Bit0
Definition	CUVE	STGS	---	---	TCS		CUVS	

Bit 0-1 CUVS: Charge curve setting

00 = Customized charging curve(default)

01 = Preset charging curve#1

10 = Preset charging curve #2

11 = Preset charging curve #3

Bit 2-3 TCS: Temperature compensation setting

00 = disable

01 = -3mV/°C/cell(default)

01 = -4mV/°C/cell

01 = -5mV/°C/cell

Bit 6 STGS: 2/3 stage charge setting

0 = 3 stage charge(dfault, CURVE\_CV and CURVE\_FV)

1 = 2 stage charge(only CURVE\_CV)

Bit 7 CUVE: Charge curve function enable

0 = Disabled, power supply mode

1 = Enabled, charger mode(default)

High byte

Bit 0 CCTOE: Constant voltage stage timeout indication enable

0 = Disabled(default)

1 = Enabled

Bit 1 CCTOE: Constant current stage timeout indication

0 = Disabled(default)

1 = Enabled

Bit 2 CCTOE: Constant current stage timeout indication enable

0 = Disabled(default)

1 = Enabled

SYSTEM\_CONFIG:

Low byte	Bit7	Bit6	Bit5	Bit4	Bit3	Bit2	Bit1	Bit0
Definition	---	---	---	---	---	OPERATION_INIT	---	---

Low byte

Bit 1-2 OPERATION\_INIT: Initial operational behavior

00 = Power on with 00h: OFF

01 = Power on with 01h: ON

10 = Power on with the last setting

11 = No used

NOTE: Conversion of setting and reading are define as follow :

Actual reading value= reading from protocol × Factor(F value).

Factor must refer to the scaling list of each mode.

EX: Vo\_real(Actual output voltage)= READ\_VOUT × Factor.

If factor of a model is 0.01 for READ\_VOUT, and protocol reads 0x0960 (Hexadecimal)= >2400(Decimal), Then Vo\_real = 2400 × 0.01 = 24.00V.

### 5.5.4 CANBus value range and tolerance

#### (1) Display parameters

CANBus Command		Model	Display value rang	Tolerance		
0x0050	READ_VIN	ALL	80 ~ 264V	±10V		
0x0060	READ_VOUT	12V	0 ~ 21V	±0.12V		
		24V	0 ~ 42V	±0.24V		
		48V	0 ~ 80V	±0.48V		
		72V	0 ~ 100V	±0.60V		
0x0061	READ_IOUT (Note)	NPB-1700	12V	0 ~ 102A	±0.85A	
			24V	0 ~ 60A	±0.50A	
			48V	0 ~ 30A	±0.25A	
		NPB-1200	12V	0 ~ 84A	±0.70A	
			24V	0 ~ 43A	±0.36A	
			48V	0 ~ 22A	±0.18A	
		NPB-750	12V	0 ~ 52A	±0.43A	
			24V	0 ~ 27A	±0.23A	
			48V	0 ~ 14A	±0.11A	
			72V	0 ~ 5.5A	±0.06A	
		NPB-450	12V	0 ~ 30A	±0.25A	
			24V	0 ~ 16A	±0.14A	
			48V	0 ~ 8A	±0.07A	
			72V	0 ~ 5.5A	±0.06A	
		0x0062	READ_TEMPERATURE_1	ALL	-40 ~ 110°C	±5°C

#### (2) Control parameters

CANBus Command		Model	Adjustable range	Tolerance	default	
0x0000	OPERATION	ALL	00h(OFF)/01h(ON)	N/A	01h (ON)	
0x0020	VOUT_SET	12V	10.5 ~ 21V	±0.12V	0V	
		24V	21 ~ 42V	±0.24V	0V	
		48V	42 ~ 80V	±0.48V	0V	
		72V	54 ~ 100V	±0.60V	0V	
0x00B1	CURVE_VBST	12V	10.5 ~ 21V	±0.12V	14.4V	
		24V	21 ~ 42V	±0.24V	28.8V	
		48V	42 ~ 80V	±0.48V	57.6V	
0x00B2	CURVE_VFLOAT	12V	10.5 ~ VBST	±0.12V	13.8V	
		24V	21 ~ VBST	±0.24V	27.6V	
		48V	42 ~ VBST	±0.48V	55.2V	
0x0030	IOUT_SET	NPB-1700	12V	17 ~ 85A	±0.85A	85A
			24V	10 ~ 50A	±0.50A	50A
			48V	5 ~ 25A	±0.25A	25A
		NPB-1200	12V	14 ~ 70A	±0.70A	70A
			24V	7.2 ~ 36A	±0.36A	36A
			48V	3.6 ~ 18A	±0.18A	18A
		NPB-750	12V	8.6 ~ 43A	±0.43A	43A
			24V	4.5 ~ 22.5A	±0.23A	22.5A
			48V	2.26 ~ 11.3A	±0.11A	11.3A
			72V	1.1 ~ 5.5A	±0.06A	5.5A
		NPB-450	12V	5 ~ 25A	±0.25A	25A
			24V	2.7 ~ 13.5A	±0.14A	13.5A
			48V	1.36 ~ 6.8A	±0.07A	6.8A
			72V	1.1 ~ 5.5A	±0.06A	5.5A

CANBus Command		Model	Adjustable range	Tolerance	default			
0x00B0	CURVE_ICHG	NPB-1700	12V	17 ~ 85A	±0.85A	85A		
			24V	10 ~ 50A	±0.50A	50A		
			48V	5 ~ 25A	±0.25A	25A		
		NPB-1200	12V	14 ~ 70A	±0.70A	70A		
			24V	7.2 ~ 36A	±0.36A	36A		
			48V	3.6 ~ 18A	±0.18A	18A		
		NPB-750	12V	8.6 ~ 43A	±0.43A	43A		
			24V	4.5 ~ 22.5A	±0.23A	22.5A		
			48V	2.26 ~ 11.3A	±0.11A	11.3A		
		NPB-450	12V	5 ~ 25A	±0.25A	25A		
			24V	2.7 ~ 13.5A	±0.14A	13.5A		
			48V	1.36 ~ 6.8A	±0.07A	6.8A		
			72V	1.1 ~ 5.5A	±0.06A	5.5A		
		0x00B3	CURVE_ITAPER	NPB-1700	12V	1.7 ~ 25.5A	±0.85A	8.5A
					24V	1 ~ 15A	±0.50A	5A
					48V	0.5 ~ 7.5A	±0.25A	2.5A
NPB-1200	12V			1.4 ~ 21A	±0.70A	7A		
	24V			0.72 ~ 10.8A	±0.36A	3.6A		
	48V			0.36 ~ 5.4A	±0.18A	1.8A		
NPB-750	12V			0.86 ~ 12.9A	±0.43A	4.3A		
	24V			0.45 ~ 6.75A	±0.23A	2.25A		
	48V			0.23 ~ 3.39A	±0.11A	1.13A		

CANBus Command		Model	Adjustable range	Tolerance	default	
0x00B3	CURVE_ITAPER	NPB-450	12V	0.5 ~ 7.5A	±0.25A	2.5A
			24V	0.27 ~ 4.05A	±0.14A	1.35A
			48V	0.14 ~ 2.04A	±0.07A	0.68A
			72V	0.11 ~ 1.65A	±0.06A	0.55A
0x00B4	CURVE_CONFIG	ALL	N/A	N/A	0004h	
0x00B5	CURVE_CC_TIMEOUT	ALL	60 ~ 64800 minute	±5 minute	600 minute	
0x00B6	CURVE_CV_TIMEOUT					
0x00B7	CURVE_FLOAT_TIMEOUT					
0x00C2	SYSTEM_CONFIG					ALL

NOTE: When the reading below the value in following table, READ\_IOUT will show 0A.

Models	Least current displayed	
NPB-1700	12V	0.85A±0.85A
	24V	0.5A±0.5A
	48V	0.25A±0.25A
NPB-1200	12V	0.7A±0.7A
	24V	0.36A±0.36A
	48V	0.18A±0.18A
NPB-750	12V	0.43A±0.43A
	24V	0.23A±0.23A
	48V	0.11A±0.11A
NPB-450	12V	0.25A±0.25A
	24V	0.14A±0.14A
	48V	0.07A±0.07A
	72V	0.06A±0.06A

## 6. Protections and failure correction

### 6.1 Protections

#### 6.1.1 Input under voltage protection(NPB-1200/1700)

When input voltage dropped, under voltage protection will activate and shut down the charger. When input voltage back to operating rang, charger will auto recover.

#### 6.1.2 Over voltage protection

When output voltage over specification, over voltage protection will be activated, and shuts down. When the faulty condition removed, re-power on to remove the protection.

#### 6.1.3 Short circuit protection

When output circuit is shorted, charger will stay in constant current mode to limit the output, and shut down after 5s. Re-power on to recover, after removing faulty condition.

#### 6.1.4 Battery under voltage and over voltage protections (NPB-450/750/1200/1700)

When the voltage of battery is too low(8V(12V model)/16V(24V model)/32V(48Vmodel)/40V(72V model)), charge will shut down to prevent damage to the battery. More to that, when the voltage of battery is too high, charger will also turn off to protect the circuitry. Re-power on after the faulty condition is removed.

#### 6.1.5 Over temperature protection

When the internal temperature of charger is too high, charger will shut down for protection. Charger will turn back on automatically if the temperature dropped down.

#### 6.1.6 Battery reverse polarity protection(NPB-120/240/360/450/750/1200/1700)

NPB-120/240/360 has a built-in fuse and diode. When the polarity is reversed, the charger output will be off and the fuse will blow for protection.

NPB-450/750/1200/1700 has a built-in battery reverse connection detection circuit. When the battery is reversed, the charger will turned off for protection.

### 6.2 Failure correction

Status	Possible cause	Suggestions for Fault correction
Charger is not charging	Power OFF	Please turn ON the charger
	Remote OFF	Please ensure remote on/off connect to 12V properly.
Battery can not be fully charged	Aged battery or malfunction	Change to a new battery
	Small cross-section of cable	Choose a proper cable for usage
	Wrong charging curve	Double check the characteristic of battery
LED indicator showed abnormal situation	Over temperature	Re-start the charger after temperature dropped back
	Battery's BMS causing malfunction of charger	Please contact battery's manufacture for detail of BMS
	Voltage of battery is not compatible	Please check the specification of battery for feasibility
	Abnormal of battery is detected	Please ensure the status of battery is normal

**Please contact MEAN WELL's distributor if above faulty condition is not removable.**

## 7.Warranty

This product provide three years warranty under normal usage. Do not replace parts or any form of modification to the product in order to keep the warranty effectively

※ MEAN WELL possess the right to adjust the content of this manual. Please refer to the latest version of our manual on our website ◦  
<https://www.meanwell.com>





明緯企業股份有限公司

MEAN WELL ENTERPRISES CO., LTD.

248 新北市五股區五權三路28號

No.28, Wuquan 3rd Rd., Wugu Dist., New Taipei City 248, Taiwan

Tel: 886-2-2299-6100 Fax: 886-2-2299-6200

<http://www.meanwell.com> E-mail: [info@meanwell.com](mailto:info@meanwell.com)